

RIGOL

User Guide

DP800 Series Programmable Linear DC Power Supply

Jun. 2021
RIGOL TECHNOLOGIES CO., LTD.

Guaranty and Declaration

Copyright

© 2021 **RIGOL** TECHNOLOGIES CO., LTD. All Rights Reserved.

Trademark Information

RIGOL® is the trademark of **RIGOL** TECHNOLOGIES CO., LTD.

Publication Number

UGH04110-1110

Software Version

00.01.17

Software upgrade might change or add product features. Please acquire the latest version of the manual from **RIGOL** website or contact **RIGOL** to upgrade the software.

Notices

- **RIGOL** products are covered by P.R.C. and foreign patents, issued and pending.
- **RIGOL** reserves the right to modify or change parts of or all the specifications and pricing policies at the company's sole decision.
- Information in this publication replaces all previously released materials.
- Information in this publication is subject to change without notice.
- **RIGOL** shall not be liable for either incidental or consequential losses in connection with the furnishing, use, or performance of this manual, as well as any information contained.
- Any part of this document is forbidden to be copied, photocopied, or rearranged without prior written approval of **RIGOL**.

Product Certification

RIGOL guarantees that this product conforms to the national and industrial standards in China as well as the ISO9001:2015 standard and the ISO14001:2015 standard. Other international standard conformance certifications are in progress.

Contact Us

If you have any problem or requirement when using our products or this manual, please contact **RIGOL**.

E-mail: service@rigol.com

Website: www.rigol.com

Safety Requirement

General Safety Summary

Please review the following safety precautions carefully before putting the instrument into operation so as to avoid any personal injury or damage to the instrument and any product connected to it. To prevent potential hazards, please follow the instructions specified in this manual to use the instrument properly.

Use Proper Power Cord.

Only the exclusive power cord designed for the instrument and authorized for use within the local country could be used.

Ground the Instrument.

The instrument is grounded through the Protective Earth lead of the power cord. To avoid electric shock, connect the earth terminal of the power cord to the Protective Earth terminal before connecting any input or output terminals.

Connect the Probe Correctly.

If a probe is used, the probe ground lead must be connected to earth ground. Do not connect the ground lead to high voltage. Improper way of connection could result in dangerous voltages being present on the connectors, controls or other surfaces of the oscilloscope and probes, which will cause potential hazards for operators.

Observe All Terminal Ratings.

To avoid fire or shock hazard, observe all ratings and markers on the instrument and check your manual for more information about ratings before connecting the instrument.

Use Proper Overvoltage Protection.

Ensure that no overvoltage (such as that caused by a bolt of lightning) can reach the product. Otherwise, the operator might be exposed to the danger of an electric shock.

Do Not Operate Without Covers.

Do not operate the instrument with covers or panels removed.

Do Not Insert Anything into the Air Outlet.

Do not insert anything into the air outlet to avoid damage to the instrument.

Use Proper Fuse.

Please use the specified fuses.

Avoid Circuit or Wire Exposure.

Do not touch exposed junctions and components when the unit is powered on.

Do Not Operate with Suspected Failures.

If you suspect that any damage may occur to the instrument, have it inspected by **RIGOL** authorized personnel before further operations. Any maintenance, adjustment or replacement especially to circuits or accessories must be performed by **RIGOL** authorized personnel.

Provide Adequate Ventilation.

Inadequate ventilation may cause an increase of temperature in the instrument, which would cause damage to the instrument. So please keep the instrument well ventilated and inspect the air outlet and the fan regularly.

Do Not Operate in Wet Conditions.

To avoid short circuit inside the instrument or electric shock, never operate the instrument in a humid environment.

Do Not Operate in an Explosive Atmosphere.

To avoid personal injuries or damage to the instrument, never operate the instrument in an explosive atmosphere.

Keep Instrument Surfaces Clean and Dry.

To avoid dust or moisture from affecting the performance of the instrument, keep the surfaces of the instrument clean and dry.

Prevent Electrostatic Impact.

Operate the instrument in an electrostatic discharge protective environment to avoid damage induced by static discharges. Always ground both the internal and external conductors of cables to release static before making connections.

Use the Battery Properly.

Do not expose the battery (if available) to high temperature or fire. Keep it out of the reach of children. Improper change of a battery (lithium battery) may cause an explosion. Use the **RIGOL** specified battery only.

Handle with Caution.

Please handle with care during transportation to avoid damage to keys, knobs, interfaces, and other parts on the panels.

Do Not Provide Power for the Active Load.

To avoid the anti-irrigation current which leads to the power control loop out of control and damages the powered device, this power supply can only provide power for the pure load without the current output function.

Safety Notices and Symbols

Safety Notices in this Manual:



WARNING

Indicates a potentially hazardous situation or practice which, if not avoided, will result in serious injury or death.



CAUTION

Indicates a potentially hazardous situation or practice which, if not avoided, could result in damage to the product or loss of important data.

Safety Terms on the Product:

DANGER It calls attention to an operation, if not correctly performed, could result in injury or hazard immediately.

WARNING It calls attention to an operation, if not correctly performed, could result in potential injury or hazard.

CAUTION It calls attention to an operation, if not correctly performed, could result in damage to the product or other devices connected to the product.

Safety Symbols on the Product:



Hazardous Voltage



Safety Warning



Protective Earth Terminal



Chassis Ground



Test Ground

Allgemeine Sicherheits Informationen

Überprüfen Sie die folgenden Sicherheitshinweise sorgfältig, um Personenschäden oder Schäden am Gerät und an damit verbundenen weiteren Geräten zu vermeiden. Zur Vermeidung von Gefahren, nutzen Sie bitte das Gerät nur so, wie in diesem Handbuch angegeben.

Um Feuer oder Verletzungen zu vermeiden, verwenden Sie ein ordnungsgemäßes Netzkabel.

Verwenden Sie für dieses Gerät nur das für ihr Land zugelassene und genehmigte Netzkabel.

Erden des Gerätes.

Das Gerät ist durch den Schutzleiter im Netzkabel geerdet. Um Gefahren durch elektrischen Schlag zu vermeiden, ist es unerlässlich, die Erdung durchzuführen. Erst dann dürfen weitere Ein- oder Ausgänge verbunden werden.

Anschluss eines Tastkopfes.

Die Erdungsklemmen der Sonden sind auf dem gleichen Spannungspegel des Instruments geerdet. Schließen Sie die Erdungsklemmen an keine hohe Spannung an.

Beachten Sie alle Anschlüsse.

Zur Vermeidung von Feuer oder Stromschlag, beachten Sie alle Bemerkungen und Markierungen auf dem Instrument. Befolgen Sie die Bedienungsanleitung für weitere Informationen, bevor Sie weitere Anschlüsse an das Instrument legen.

Verwenden Sie einen geeigneten Überspannungsschutz.

Stellen Sie sicher, daß keinerlei Überspannung (wie z.B. durch Gewitter verursacht) das Gerät erreichen kann. Andernfalls besteht für den Anwender die Gefahr eines Stromschlages.

Nicht ohne Abdeckung einschalten.

Betreiben Sie das Gerät nicht mit entfernten Gehäuse-Abdeckungen.

Betreiben Sie das Gerät nicht geöffnet.

Der Betrieb mit offenen oder entfernten Gehäuseteilen ist nicht zulässig. Nichts in entsprechende Öffnungen stecken (Lüfter z.B.)

Passende Sicherung verwenden.

Setzen Sie nur die spezifikationsgemäßen Sicherungen ein.

Vermeiden Sie ungeschützte Verbindungen.

Berühren Sie keine unisolierten Verbindungen oder Baugruppen, während das Gerät in Betrieb ist.

Betreiben Sie das Gerät nicht im Fehlerfall.

Wenn Sie am Gerät einen Defekt vermuten, sorgen Sie dafür, bevor Sie das Gerät wieder betreiben, dass eine Untersuchung durch **RIGOL** autorisiertem Personal durchgeführt wird. Jedwede Wartung, Einstellarbeiten oder Austausch von Teilen am Gerät, sowie am Zubehör dürfen nur von **RIGOL** autorisiertem Personal durchgeführt werden.

Belüftung sicherstellen.

Unzureichende Belüftung kann zu Temperaturanstiegen und somit zu thermischen Schäden am Gerät führen. Stellen Sie deswegen die Belüftung sicher und kontrollieren regelmäßig Lüfter und Belüftungsöffnungen.

Nicht in feuchter Umgebung betreiben.

Zur Vermeidung von Kurzschluß im Geräteinneren und Stromschlag betreiben Sie das Gerät bitte niemals in feuchter Umgebung.

Nicht in explosiver Atmosphäre betreiben.

Zur Vermeidung von Personen- und Sachschäden ist es unumgänglich, das Gerät ausschließlich fernab jedweder explosiven Atmosphäre zu betreiben.

Geräteoberflächen sauber und trocken halten.

Um den Einfluß von Staub und Feuchtigkeit aus der Luft auszuschließen, halten Sie bitte die Geräteoberflächen sauber und trocken.

Schutz gegen elektrostatische Entladung (ESD).

Sorgen Sie für eine elektrostatisch geschützte Umgebung, um somit Schäden und Funktionsstörungen durch ESD zu vermeiden. Erden Sie vor dem Anschluß immer Innen- und Außenleiter der Verbindungsleitung, um statische Aufladung zu entladen.

Die richtige Verwendung des Akku.

Wenn eine Batterie verwendet wird, vermeiden Sie hohe Temperaturen bzw. Feuer ausgesetzt werden. Bewahren Sie es außerhalb der Reichweite von Kindern auf. Unsachgemäße Änderung der Batterie (Anmerkung: Lithium-Batterie) kann zu einer Explosion führen. Verwenden Sie nur von **RIGOL** angegebene Akkus.

Sicherer Transport.

Transportieren Sie das Gerät sorgfältig (Verpackung!), um Schäden an Bedienelementen, Anschlüssen und anderen Teilen zu vermeiden.

Vermeiden Sie das Einprägen von Strom und Spannung an den Testklemmen.

Das DP800 Power Supply kann hierdurch zerstört werden, keine aktive Last. Das DP800 kann nur Strom und Spannungen liefern.

Sicherheits Begriffe und Symbole

Begriffe in diesem Guide:



WARNING

Die Kennzeichnung WARNING beschreibt Gefahrenquellen die leibliche Schäden oder den Tod von Personen zur Folge haben können.



CAUTION

Die Kennzeichnung Caution (Vorsicht) beschreibt Gefahrenquellen die Schäden am Gerät hervorrufen können.

Begriffe auf dem Produkt:

DANGER weist auf eine Verletzung oder Gefährdung hin, die sofort geschehen kann.

WARNING weist auf eine Verletzung oder Gefährdung hin, die möglicherweise nicht sofort geschehen.

CAUTION weist auf eine Verletzung oder Gefährdung hin und bedeutet, dass eine mögliche Beschädigung des Instruments oder anderer Gegenstände auftreten kann.

Symbole auf dem Produkt:



Gefährliche Spannung



Sicherheits-Hinweis



Schutz-erde



Gehäusemasse



Erde

Care and Cleaning

Care

Do not store or leave the instrument where it may be exposed to direct sunlight for long periods of time.

Cleaning

Clean the instrument regularly according to its operating conditions.

1. Disconnect the instrument from all power sources.
2. Clean the external surfaces of the instrument with a soft cloth dampened with mild detergent or water. Avoid having any water or other objects into the chassis via the heat dissipation hole. When cleaning the LCD, take care to avoid scarifying it.



CAUTION

To avoid damage to the instrument, do not expose it to caustic liquids.



WARNING

To avoid short-circuit resulting from moisture or personal injuries, ensure that the instrument is completely dry before connecting it to the power supply.

Environmental Considerations

The following symbol indicates that this product complies with the requirements in WEEE Directive 2002/96/EC.



Product End-of-Life Handling

The equipment may contain substances that could be harmful to the environment or human health. To avoid the release of such substances into the environment and avoid harm to human health, we recommend you to recycle this product appropriately to ensure that most materials are reused or recycled properly. Please contact your local authorities for disposal or recycling information.

You can click on the following link <https://int.rigol.com/services/declaration.html> to download the latest version of the RoHS&WEEE certification file.

DP800 Series Overview

DP800 series is high-performance programmable linear DC power supply. DP800 series which provides clear user interface, superb performance specifications, various analysis functions as well as various communication interfaces can fulfill versatile test requirements.

Main Features:

User-friendly Design:

- 3.5-inch TFT display, displaying multiple parameters and states at the same time
- Support Chinese/English interface and input method
- Novel and exquisite industrial design and easy operation
- Provide waveform display function to provide real-time and dynamic display of the output voltage/current waveform, clearly showing the output state and tendency of the instrument in together with the digital display of the voltage, current and power values
- Provide dial display function, indicating the current output state using the dial pointer by simulating the traditional power display mode
- Provide on-line help system for easy acquisition of help information

Multiple Safety Protection:

- Provide overvoltage/overcurrent protection function; users can set the overvoltage and overcurrent parameters to realize effective protection of the load
- Provide secondary over-temperature protection function to realize double over-temperature protection of the software and hardware
- Provide intelligent fan speed control function; judge and control the fan speed automatically according to the working condition to effectively reduce the fan noise
- Provide fan failure check and alarm function
- Provide keyboard lock function to avoid misoperation

Various Functions and Superb Performance:

- Multi-channel output; up to 200W total output power; the output of each channel can be controlled independently
- Superb load regulation rate and linear regulation rate
- Provide ultra-low output ripples and noise
- Provide timing output function and support infinite and specified number of cycles of output
- Provide track function to track the channel voltage setting value and output on/off status
- Provide Sense function to automatically compensate for the voltage drop caused by the load lead in high current output.
- Provide delay on/off output function and support infinite or specified number of cycles of channel on/off toggle

-
- Support digital trigger (option) to realize digital trigger input and trigger output functions
 - Support on-line analyzer (option) to perform on-line analysis of various statistic parameters
 - Support monitor (option) to monitor the output according to the user-defined monitor condition
 - Provide built-in recorder to perform background recording of the output state after power-on according to certain record period
 - Provide dedicated preset key to perform one-key reset and one-key recall of the commonly used output voltage and current configurations
 - Support serial and parallel output functions
 - Support on-line self-test and manual calibration functions
 - Provide store and recall function
 - Support voltage and current linear programmable functions

Complete Interface Configurations and Flexible Control Method:

- Standard configuration interfaces: USB HOST, USB DEVICE, LAN (option), RS232 (option), Digital I/O (option), rear panel output interface (DP813/DP811)
- Support to extend a GPIB interface via the USB-GPIB interface converter (option)
- Support USB storage device (FAT32 format, flash memory) storage
- Support SCPI remote command control
- Conform to LXI Core 2011 Device instrument standard
- Provide standard 9 pin RS232 interface with flow control function
- Provide 4-wire digital I/O interface which supports the trigger input/output function

Document Overview

Chapter 1 Quick Start

Introduce the appearance and dimensions, front panel, rear panel as well as user interface of DP800. In addition, it provides the detailed procedures of power connection, power-on inspection, and fuse replacement.

Chapter 2 Front Panel Operations

Introduce the function and operation method of each key on the front panel of DP800 in detail.

Chapter 3 Remote Control

Introduce how to realize the remote control of the instrument.

Chapter 4 Troubleshooting

Introduce the possible failures and their solutions when using DP800.

Chapter 5 Specifications

List the specifications of DP800.

Chapter 6 Appendix

Provide the accessory and option list as well as the warranty information of DP800.

Index

Provide keyword search to quickly locate the desired information.

Tip

For the latest version of this manual, download it from **RIGOL** official website (www.rigol.com).

Format Conventions in this Manual

1. Key

The function key on the front panel is denoted by the format of "Key Name (Bold) + Text Box" in the manual. For example, **Utility** denotes the "Utility" key.

2. Menu

The menu item is denoted in the following two modes in this manual.

- (1) The menu item can be denoted by the format of "Menu Word (Bold) + Character Shading". For example, **System** denotes the "System" item under **Utility**.
- (2) The menu item can be denoted by the screenshot of the menu key. For example, .

3. Operation Step

The next step of the operation is denoted by an arrow "→" in the manual. For example, **Utility** → **System** denotes that first press **Utility** on the front panel and then press **System**.

Content Conventions in this Manual

DP800 series programmable linear DC power supply includes the following models. Unless otherwise noted, this manual illustrates the functions and operation methods of DP800 series by taking DP832 as an example.

Model	Number of Channels	Channel Output Voltage/Current
DP832	3	30V/3A, 30V/3A, 5V/3A
DP831	3	8V/5A, 30V/2A, -30V/2A
DP822	2	20V/5A, 5V/16A
DP821	2	60V/1A, 8V/10A
DP813	1	Range1: 8V/20A; Range2: 20V/10A
DP811	1	Range1: 20V/10A; Range2: 40V/5A

Contents

Guaranty and Declaration	I
Safety Requirement	II
General Safety Summary	II
Safety Notices and Symbols.....	IV
Allgemeine Sicherheits Informationen.....	V
Sicherheits Begriffe und Symbole	VII
Care and Cleaning	VIII
Environmental Considerations.....	IX
DP800 Series Overview	X
Document Overview.....	XII
Chapter 1 Quick Start	1-1
General Inspection.....	1-2
Appearance and Dimensions.....	1-3
Front Panel	1-4
Rear Panel	1-11
To Connect to Power.....	1-13
Power-on Inspection	1-14
To Replace the Fuse.....	1-14
User Interface	1-16
To Use the Built-in Help System	1-18
Chapter 2 Front Panel Operations.....	2-1
Constant Voltage Output	2-2
Constant Current Output	2-6
Power Supply Series and Parallel Connections	2-8
Power Supply Series Connection.....	2-8
Power Supply Parallel Connection	2-9
Track Function.....	2-10
To Enable the Track Function	2-10
To Track the On/Off Status of the Channel Output	2-12
Sense Working Mode	2-13
Timer and Delayer	2-15
To Set the Timer Parameters.....	2-16
To Enable the Timer	2-25
To Set the Delay Parameters	2-26
To Enable the Delayer	2-30
Advanced Functions.....	2-31
Recorder	2-32
Analyzer (option)	2-33
Monitor (option).....	2-36
Trigger (option)	2-37

Display Setting	2-41
Brightness	2-41
Contrast	2-41
RGB Luminance.....	2-41
Display Mode	2-42
Display Theme	2-42
User-defined Start-up Interface	2-43
Store and Recall	2-45
Browser.....	2-46
File Type.....	2-46
Save	2-47
Read	2-49
Delete	2-49
Copy and Paste	2-50
Utility.....	2-51
I/O Configuration	2-52
System Setting.....	2-57
System Information.....	2-59
System Language.....	2-59
Test/Calibration.....	2-59
Print.....	2-60
Preset Setting	2-61
Options	2-68
Key Locking.....	2-70
Chapter 3 Remote Control.....	3-1
Remote Control via USB	3-2
Remote Control via LAN (option).....	3-5
Remote Control via GPIB (option)	3-8
Remote Control via RS232 (option)	3-10
Chapter 4 Troubleshooting.....	4-1
Chapter 5 Specifications.....	5-1
Chapter 6 Appendix.....	6-1
Appendix A: Accessories and Options	6-1
Appendix B: Warranty	6-2
Index.....	1

Chapter 1 Quick Start

The contents of this chapter are as follows:

- General Inspection
- Appearance and Dimensions
- Front Panel
- Rear Panel
- To Connect to Power
- Power-on Inspection
- To Replace the Fuse
- User Interface
- To Use the Built-in Help System

General Inspection

1. Inspect the packaging

If the packaging has been damaged, do not dispose the damaged packaging or cushioning materials until the shipment has been checked for completeness and has passed both electrical and mechanical tests.

The consigner or carrier shall be liable for the damage to the instrument resulting from shipment. **RIGOL** would not be responsible for free maintenance/rework or replacement of the instrument.

2. Inspect the instrument

In case of any mechanical damage, missing parts, or failure in passing the electrical and mechanical tests, contact your **RIGOL** sales representative.

3. Check the accessories

Please check the accessories according to the packing lists. If the accessories are damaged or incomplete, please contact your **RIGOL** sales representative.

Appearance and Dimensions

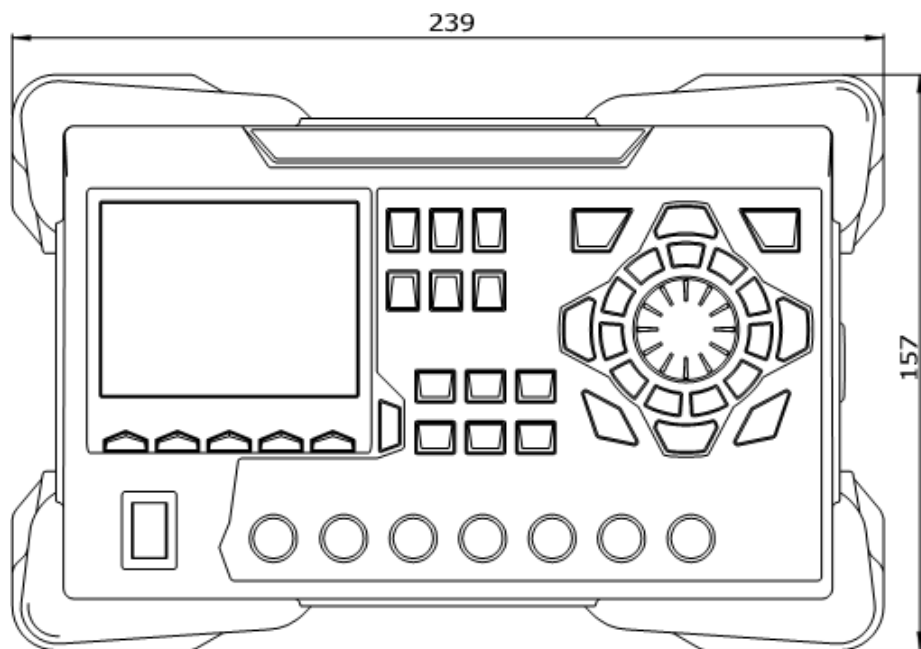

Figure 1-1 Front View

Unit: mm

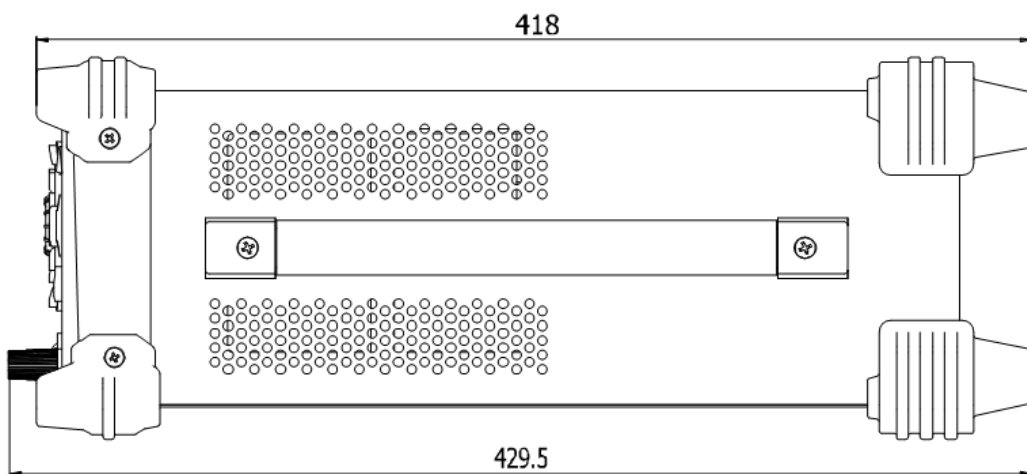

Figure 1-2 Side View

Unit: mm

Front Panel

This section introduces the front panel of DP800 series by taking DP832 (as shown in the figure below) as an example. The differences of different models are introduced separately.

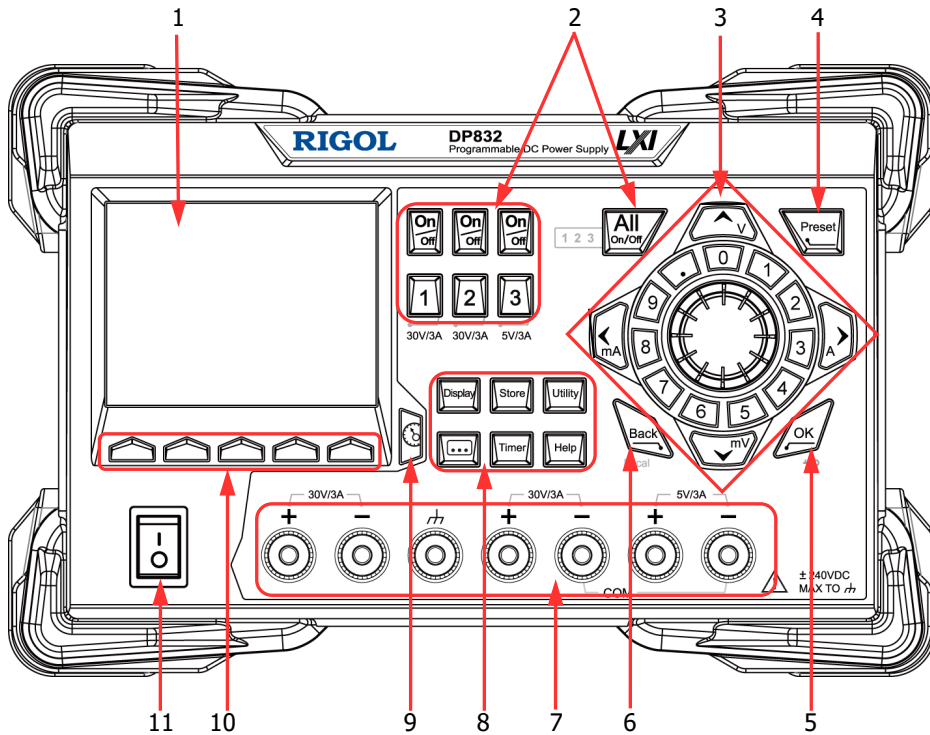

Figure 1-3 DP832 Front Panel

1. LCD

3.5-inch TFT display. It is used to display the system parameter setting, system output state, menu items, prompt messages, etc.

2. Channel (Range) Selection and Output Switch

For the multi-channel model, the function of this part is channel selection and output switch. For the single-channel model, the function of this part is range selection and output switch.

Multi-channel models (take DP832 as an example):

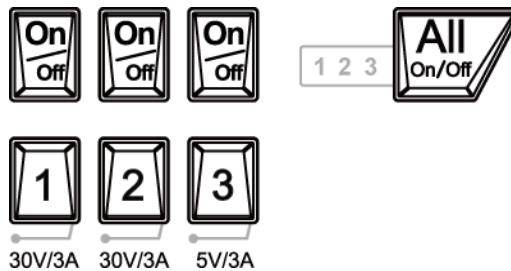

Press this key to select CH1 as the current channel and you can set the parameters of this channel, such as voltage, current and overvoltage/overcurrent protection.



Press this key to select CH2 as the current channel and you can set the parameters of this channel, such as voltage, current and overvoltage/overcurrent protection.



Press this key to select CH3 as the current channel and you can set the parameters of this channel, such as voltage, current and overvoltage/overcurrent protection.



Press this key to enable or disable the output of the corresponding channel.



Press this key and the prompt message asking whether to enable the outputs of all the channels will be displayed. Press **OK** to enable the outputs of all the channels. Pressing this key again will disable the outputs of all the channels.

Single-channel model (take DP811 as an example):

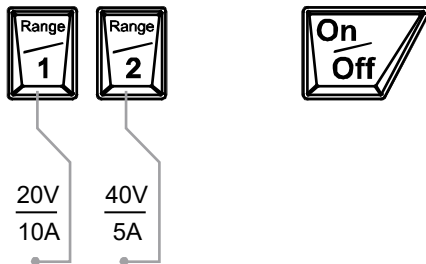

Press this key to select 20V/10A range as the current range and you can set the parameters of the channel, such as voltage, current and overvoltage/overcurrent protection.



Press this key to select 40V/5A range as the current range and you can set the parameters of the channel, such as voltage, current and overvoltage/overcurrent protection.



Press this key to enable or disable the output of the channel.

3. Parameter Input Area

The parameter input area is as shown in the figure below. This area includes the arrow keys (unit selection keys), numeric keyboard and knob.

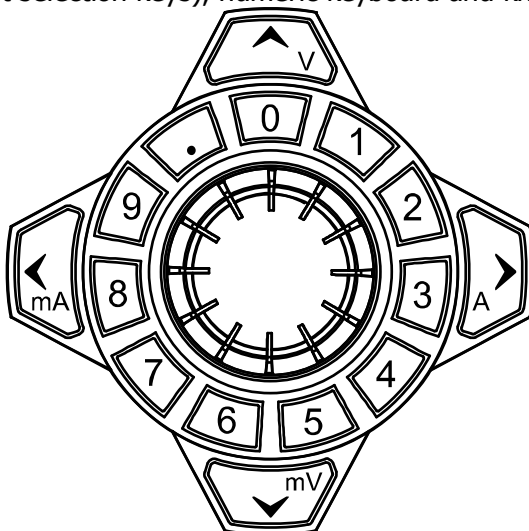

(1) Arrow keys and unit selection keys

Arrow keys: used to move the cursor. When setting parameters, use the up/down arrow key to increase or reduce the value at the cursor.

Unit selection keys: when using the numeric keyboard to input parameters,

the keys are used to enter the voltage units (V and mV) or the current units (A and mA).

(2) Numeric Keyboard

Ring-type numeric keyboard: include numbers 0-9 and the decimal point. Press the corresponding key to directly input the number or decimal point.

(3) Knob

When setting parameters, rotate the knob to increase or reduce the value at the cursor.

When browsing the setting objects (timer parameters, delay parameters, filename input, etc.), rotate the knob to quickly move the cursor.

4. **Preset**



Restore all the settings of the instrument to default values or recall the user-defined channel voltage/current configuration.

5. **OK**



Confirm the parameter setting.

Press and hold this key to lock the front panel keys; at this point,

the front panel keys (except the output on/off key  of each

channel and the power switch key ) are not available. When the keyboard lock password is disabled, press and hold this key again to unlock the front panel keys. When the keyboard lock password is enabled, you need to input the correct password (2012) to unlock the front panel keys.

6. **Back**



Delete the character currently before the cursor.

When the instrument is in remote mode, press this key to return to local mode.

7. Output Terminals

The output terminals of different models of DP800 series are different.

DP832:

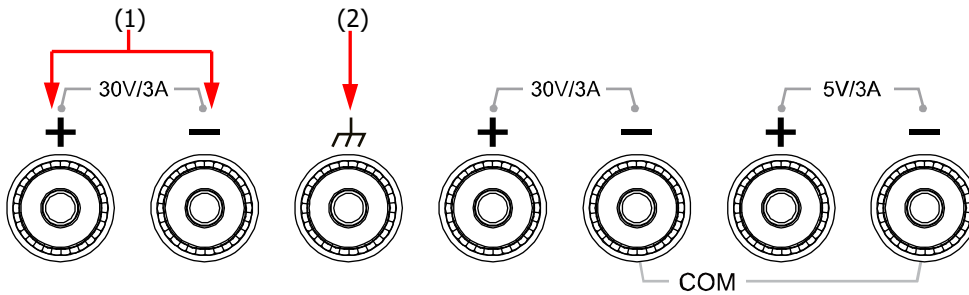

DP822/DP821:

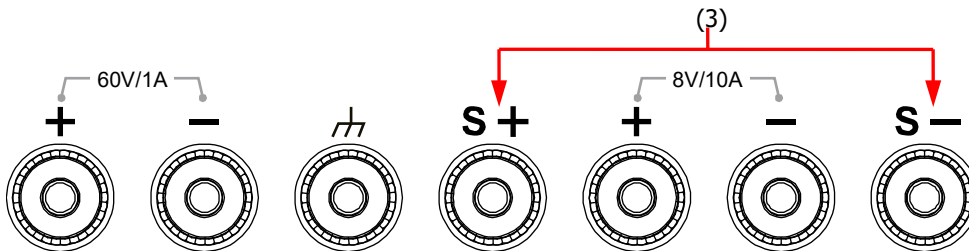

DP813/DP811:

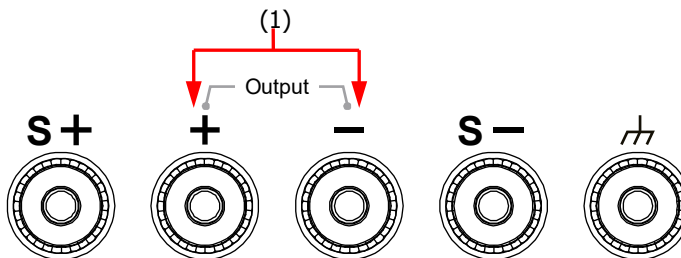

- (1) Channel output terminals: used to output the voltage and current of the channel.
- (2) Ground terminal: this terminal is connected to the instrument chassis and ground wire (the ground terminal of the power cord) and is in grounded state.
- (3) Sense terminals: used to detect the actual voltage at the load terminal to compensate for the voltage drop caused by the load lead.

Connection methods of the output terminal:

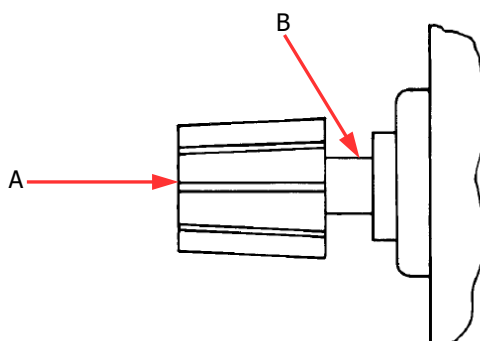

Method 1:

Connect the test lead to A of the output terminal.

Method 2:

Rotate the outer nut of the output terminal counterclockwise and connect the test lead to B of the output terminal; then, rotate the outer nut of the output terminal clockwise. This connection method can eliminate the error caused by the resistance of the output terminal.

Note: Connect the positive terminal of the test lead with the (+) terminal of the channel output and connect the negative terminal of the test lead with the (-) terminal of the channel output.

8. Function Menu Area

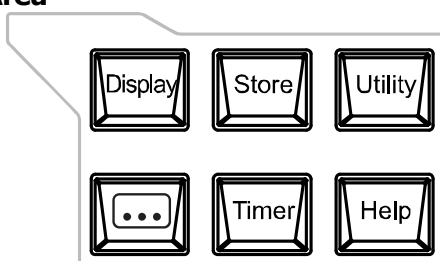

Press this key to enter the display parameter setting interface. Users can set the brightness, contrast, RGB luminance, display mode and display theme. Besides, you can also define the start-up interface.



Press this key to enter the file store and recall interface. You can save, read, delete, copy and paste files. The file types available for storage include state file, record file, timer file, delay file and bitmap file. The instrument supports internal and external storage and recall.



Press this key to enter the system utility function setting interface. Users can set the remote interface parameters, system parameters and print parameters. Besides, users can also calibrate the instrument, view system information, define the recall configuration of **Preset** and install options.



Press this key to enter the advanced function setting interface. Users can set the recorder, analyzer (option), monitor (option) and trigger (option) parameters.



Press this key to enter the timer and delayer setting interface. Users can set the timer and delayer parameters as well as enable and disable the timer and delayer functions.



Press this key to open the built-in help system and press the desired key to get the corresponding help information. For detailed introductions, refer to "**To Use the Built-in Help System**".

9. Display Mode Switch/Return to the Main Interface



Switch between the current display mode and dial display mode. Besides, when the instrument is in a function interface (any interface under **Timer**, **...**, **Display**, **Store** and **Utility**), press this key to exit the function interface and return to the main interface.

10. Menu Keys



The menu keys correspond to the menus above them respectively. Press any menu key to select the corresponding menu.

11. Power Switch Key



Turn on or off the instrument.

Rear Panel

This section introduces the rear panel of DP800 series by taking DP832 and DP811 (as shown in the figures below) as examples. The introduction of each part is as shown in Table 1-1.

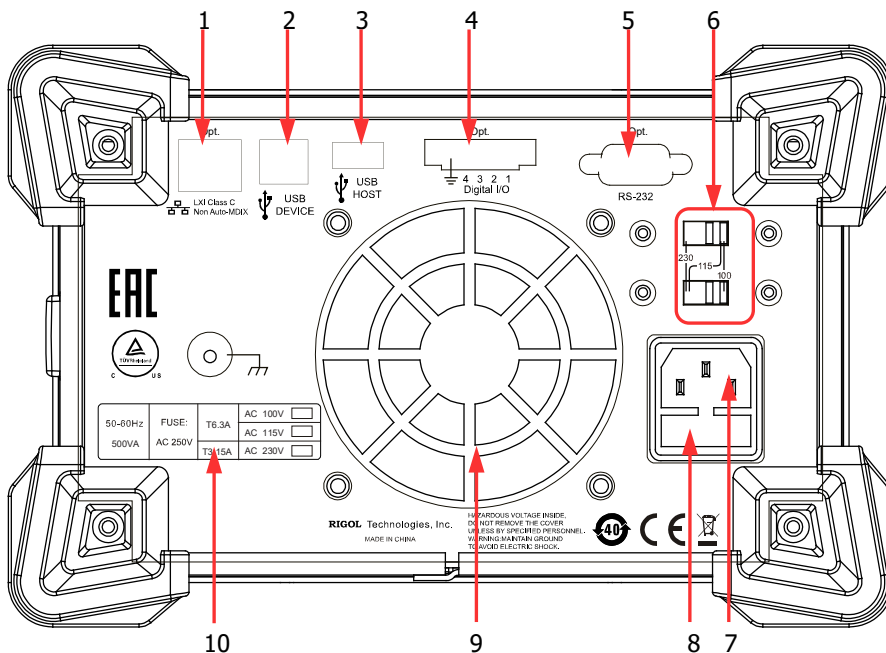

Figure 1-4 DP832 Rear Panel

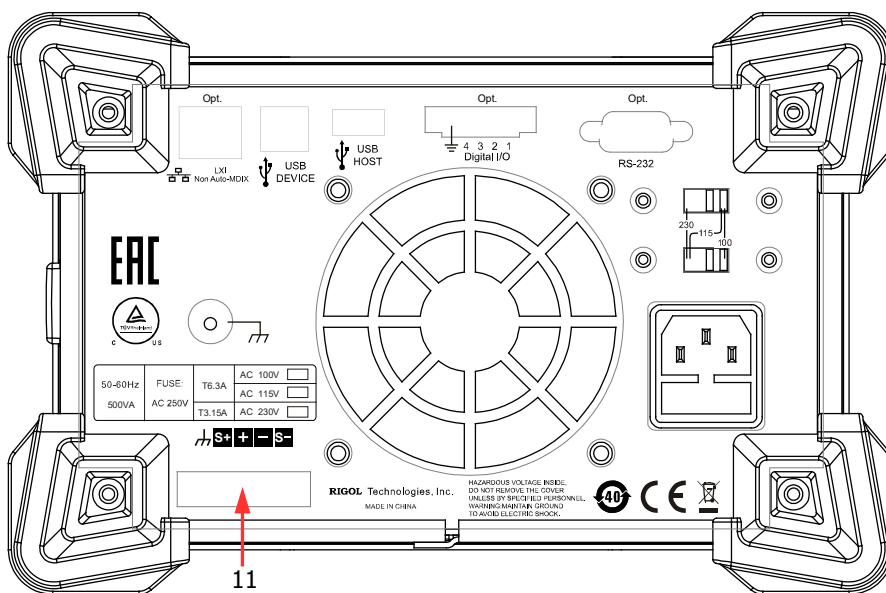

Figure 1-5 DP811 Rear Panel

Table 1-1 DP800 rear panel explanation

No.	Name	Explanation
1	LAN Interface (option)	The instrument is connected to the local network via RJ45 interface
2	USB DEVICE	Connect the instrument (as "slave" device) to external USB device (such as PC)
3	USB HOST	Connect the instrument (as "host" device) to external USB device (such as USB storage device); extend a GPIB interface for the power supply using USB-GPIB interface converter (option)
4	Digital I/O (option)	Digital I/O interface
5	RS232 Interface (option)	Serial communication interface
6	Voltage Selector	Select the specification of the input voltage (100, 115 or 230; please refer to Table 1-2)
7	Power Socket	AC power input interface.
8	Fuse	The specification of the fuse is related to the instrument model and actual input voltage (please refer to the "Input Power Requirements" on the rear panel of the instrument or refer to Table 1-3).
9	Fan	
10	Input Power Requirement	Corresponding relations of the AC input power frequency, voltage and the specification of the fuse.
11	Output Interface	Only DP813 and DP811 provide this interface. The function of this interface is the same as that of the " Output Terminals " on the front panel.

Note: The "Output Terminals" on the front panel and "Output Interface" on the rear panel cannot be used for output at the same time. You can only select one of them for output at each time (wherein, the output terminals on the front panel provide higher output accuracy).

To Connect to Power

DP800 series power supply supports various AC power supply inputs. The voltage selector setting on the rear panel differs when the input power connected is different, as shown in the table below.

Table 1-2 AC input power specifications (including voltage selector settings)

AC Input Power	Voltage Selector Setting
100Vac±10%, 50Hz to 60Hz	100
115Vac±10%, 50Hz to 60Hz	115
230Vac±10% (250Vac maximum), 50Hz to 60Hz	230

Please connect the power following the steps below.

1. Check the input power

Make sure that the AC power to be connected to the instrument fulfills the requirements in Table 1-2.

2. Check the voltage selector on the rear panel

Make sure that the voltage selector setting (110, 115 or 230) on the rear panel of the instrument matches the actual input voltage (for the matching relations refer to Table 1-2).

3. Check the fuse

When the instrument leaves factory, the specified fuse is installed. Please check whether the fuse matches the actual input voltage according to the "Input Power Requirements" on the rear panel of the instrument or Table 1-3.

4. Connect the AC power

Connect the instrument to AC power supply using the power cord provided in the accessories.



WARNING

To avoid electric shock, make sure that the instrument is correctly grounded.

Power-on Inspection

Press the power switch on the front panel, the instrument starts and executes self-test. If the instrument passes the self-test, the welcome interface will be displayed; otherwise, the corresponding self-test failure information (including the top board, bottom board, fan, and temperature) will be displayed.

Tip

When powering on the instrument after powering it off, make sure that the time interval between the two operations is greater than 5s.

To Replace the Fuse

The fuse specification is related to the instrument model and actual input voltage, as shown in the table below. You can also refer to the "Input Power Requirements" on the rear panel of the instrument.

Table 1-3 Fuse specifications

Input Voltage	Fuse Specification
DP832/DP822/DP813/DP811	
100Vac/115Vac	T6.3A
230Vac	T3.15A
DP831/DP821	
100Vac/115Vac	T5A
230Vac	T2.5A

To replace the fuse, follow the steps below.

1. Turn off the instrument and remove the power cord.
2. Insert a small straight screwdriver into the slot at the power socket and pry out the fuse seat gently.

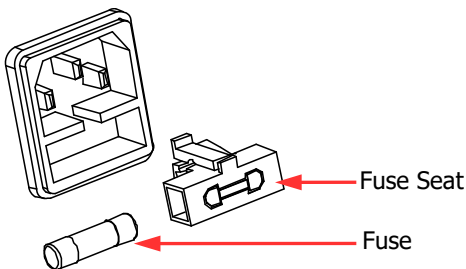

3. If needed, adjust the power voltage selector manually to select the voltage scale (please refer to Table 1-4) that matches the actual input voltage.
4. Take out the fuse and replace it with a specified one (please refer to the "Input Power Requirements" on the rear panel of the instrument or Table 1-3).
5. Re-insert the fuse seat into the power socket (pay attention to the direction).



WARNING

To avoid personal injuries, cut off the power supply before replacing the fuse; to avoid electric shock or fire, select the power supply specification that matches the actual input voltage and replace a fuse corresponding to this specification before connecting to power.

User Interface

DP800 series power supply provides three kinds of display modes (normal, waveform and dial). The default is normal. You can press **Display** → **Disp Mode** to select different display mode. This section introduces the user interface layout under the normal display mode (as shown in the figure below and Table 1-4 on the next page).

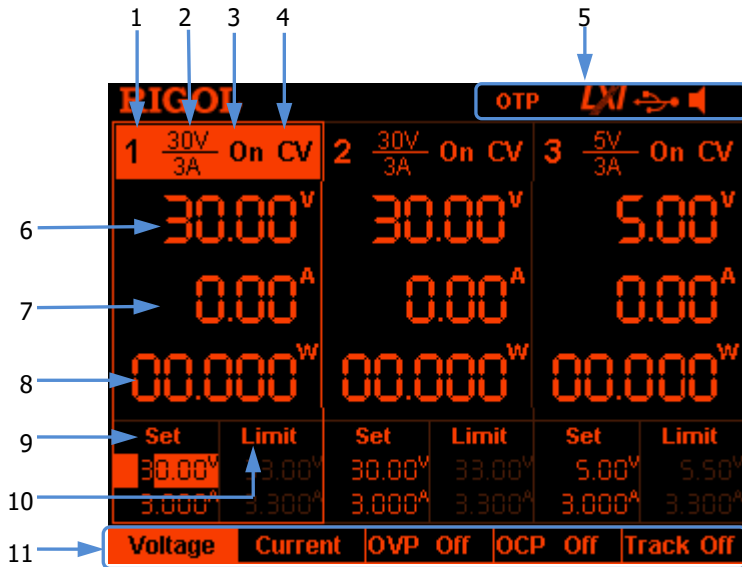









Figure 1-6 User Interface (Normal Display Mode)

Table 1-4 User Interface Explanation

No.	Explanation
1	Channel number
2	Channel output voltage/current
3	Channel output status
4	Channel output mode
5	Status bar. Display the system status labels.  : over-temperature protection is enabled  : the front panel is locked.  : the network is connected.  : USB device is recognized.  : the beeper is enabled.  : the beeper is disabled.  : the instrument is in remote mode.
6	Actual output voltage
7	Actual output current
8	Actual output power
9	Voltage and current setting values
10	Overvoltage and overcurrent protection setting values
11	Menu bar

Tip

When the current display mode is "Normal" or "Waveform", press  on the front panel to quickly switch between the current display mode and dial display mode.

To Use the Built-in Help System

The built-in help system provides help information for any front panel key (except the parameter input area) and menu keys for users to quickly obtain the function prompts of the function keys or menus.

Obtain the help information of any key or menu key

Press **Help** to illuminate it and press the desired key or menu key to get the corresponding help information; at the same time, the backlight of **Help** goes off.

Press  to exit the help system.

Built-in help interface

Press **Help** to illuminate it and press **Help** again to open the built-in help interface. Use the up/down arrow key or knob to select the desired help topic and press **View** to view the corresponding help information.

The help topics include:

1. View the last displayed message.
2. View error queue of the remote commands.
3. Get the help information of a key.
4. Storage management.
5. Abbreviation list.
6. Series-parallel Help.
7. Get technical support from **RIGOL**.

Chapter 2 Front Panel Operations

The contents of this chapter are as follows:

- Constant Voltage Output
- Constant Current Output
- Power Supply Series and Parallel Connections
- Track Function
- Sense Working Mode
- Timer and Delayer
- Advanced Functions
- Display Setting
- Store and Recall
- Utility
- Key Locking

Constant Voltage Output

DP800 series power supply provides three output modes: constant voltage output (CV), constant current output (CC) and critical mode (UR). In CV mode, the output voltage equals the voltage setting value and the output current is determined by the load; in CC mode, the output current equals the current setting value and the output voltage is determined by the load; UR is the critical mode between CV and CC. This section introduces the operation method in constant voltage output mode.

Operation Method:

1. Connect the channel output terminals
As shown in the figure below, connect the load with the channel output terminals of the corresponding channel on the front panel.

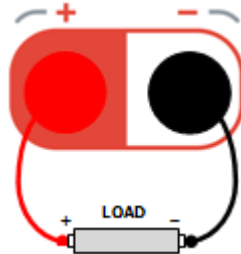



CAUTION

Pay attention to the polarity when connecting them to avoid damaging the instrument and the devices connected to the instrument.



2. Turn on the power switch to start the instrument.
3. Select the channel
Select the proper output channel according to the desired output voltage. Press the corresponding channel selection key; at this point, this channel, its channel number, output state and output mode are high-lighted on the screen.
4. Set the voltage
Method 1
Press **Voltage** and use the left/right arrow key to move the cursor; then, rotate the knob to quickly set the voltage and the default unit is V. After selecting the digit to be set, you can also use the up/down arrow key to modify the value of the corresponding digit. The default unit is V.

Method 2

Press **Voltage**, use the numeric keyboard to directly input the desired voltage value and press **V** or **mV** or press the unit selection key ( or ) to

select the desired unit. Besides, you can also press **OK** to select the default unit (V). During the input, you can press **Back** to delete the character currently before the cursor or press **Cancel** to cancel the input.

Method 3



If **Current** is currently selected, you can also use the numeric keyboard to directly input the desired voltage value; and then press the unit selection key ( or ) to select the desired voltage unit. During the input, you can press **Back** to delete the character currently before the cursor or press **Cancel** to cancel the input.

5. Set the current



Method 1

Press **Current** and use the left/right arrow key to move the cursor; then, rotate the knob to quickly set the current and the default unit is A. After selecting the digit to be set, you can also use the up/down arrow key to modify the value of the corresponding digit. The default unit is A.

Method 2

Press **Current**, use the numeric keyboard to directly input the desired current value and press **A** or **mA** or press the unit selection key ( or ) to select the desired unit. Besides, you can also press **OK** to select the default unit (A). During the input, you can press **Back** to delete the character currently before the cursor or press **Cancel** to cancel the input.

Method 3

If **Voltage** is currently selected, you can also use the numeric keyboard to directly input the desired current value; and then press the unit selection key ( or ) to select the desired current unit. During the input, you can press **Back** to delete the character currently before the cursor or press **Cancel** to cancel the input.

6. Set the overcurrent protection

Press **OCP** to set a proper overcurrent protection value (for the setting method, refer to "**Set the current**"). Then, enable the overcurrent protection function (you can enable or disable the OCP function by pressing **OCP**) and the output will be turned off automatically when the actual output current is greater than the overcurrent protection value.

7. Turn on the output

Turn on the output of the corresponding channel and the actual output voltage, output current, output power as well as the output mode (CV) are high-lighted in the user interface.

**Warning**

To avoid electric shock, please turn on the output switch after the output terminals are correctly connected.

**CAUTION**

When the fan stops, the channel switch can not be turned on; otherwise, "The fan stops, stop the output!" will be displayed.

8. Check the output mode
In constant voltage output mode, the output mode displayed should be "CV"; if "CC" is displayed, you can increase the current setting value properly and the power supply will switch to CV mode automatically.

In addition, DP813/DP811 provides an output interface on the rear panel for constant voltage output. As shown in the figure below, connect the load and the output interface on the rear panel via the connecting terminal.

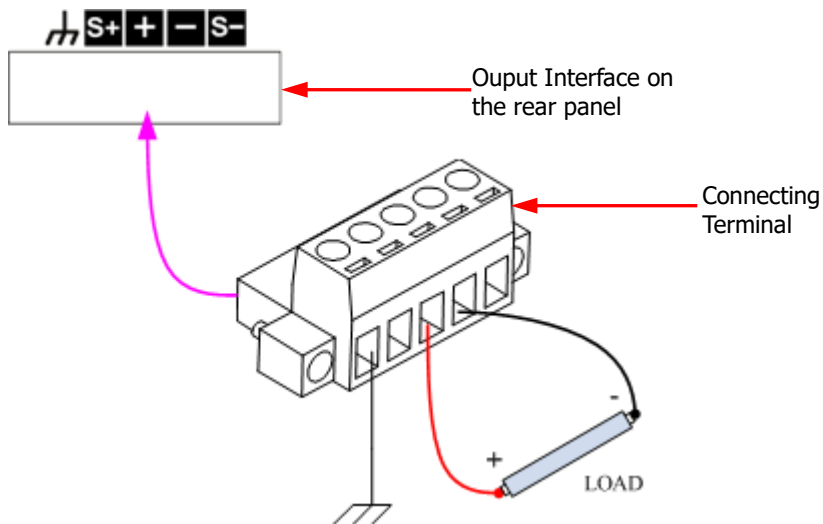
**Connecting Procedures:**

1. Connect the load to the corresponding positions on the connecting terminal correctly. Pay attention to the polarity when making connections.
2. Insert the connecting terminal into the output interface on the rear panel of the instrument. Pay attention to the corresponding relations of the connecting terminal and the output interface.

Note: The output terminals on the front panel and the output interface on the rear panel cannot be used for output at the same time. You can only select one of them for output at each time (wherein, the output terminals on the front panel provide

higher output accuracy).

Tip

In CV output mode, when the load current is greater than the current setting value, the power supply will switch to CC output mode automatically. At this point, the output current equals the current setting value and the output voltage reduces proportionally.

Constant Current Output

In constant current output mode, the output current equals the current setting value and the output voltage is determined by the load. This section introduces the operation method in constant current output mode.

Operation Method:

1. Connect the channel output terminals
Connect the load with the channel output terminals of the corresponding channel on the front panel by referring to "**Connect the channel output terminals**" in "Constant Voltage Output".
2. Turn on the power switch to start the instrument.
3. Select the channel
Select the proper output channel according to the desired output current. Press the corresponding channel selection key; at this point, this channel, its channel number, output state and output mode are high-lighted on the screen.
4. Set the voltage
Press **Voltage** to set the desired voltage according to "**Set the voltage**" in "Constant Voltage Output".
5. Set the current
Press **Current** to set the desired current according to "**Set the current**" in "Constant Voltage Output".
6. Set the overvoltage protection
Press **OVP** to set a proper overvoltage protection value (for the setting method, refer to "**Set the voltage**" in "Constant Voltage Output"). Then, enable the overvoltage protection function (you can enable or disable the OVP function by pressing **OVP**) and the output will be turned off automatically when the actual output voltage is greater than the overvoltage protection value.
7. Turn on the output
Turn on the output of the corresponding channel and the actual output voltage, output current, output power as well as the output mode (CC) are high-lighted in the user interface.



Warning

To avoid electric shock, please turn on the output switch after the output terminals are correctly connected.

**CAUTION**

When the fan stops, the channel switch cannot be turned on; otherwise, "The fan stops, stop the output!" will be displayed.

8. Check the output mode

In constant current output mode, the output mode displayed should be "CC"; if "CV" is displayed, you can increase the voltage setting value properly and the power supply will switch to CC mode automatically.

In addition, DP813/DP811 provides an output interface on the rear panel for constant current output. For the connecting method, please refer to the related introduction in "**Constant Voltage Output**".

Note: The output terminals on the front panel and the output interface on the rear panel cannot be used for output at the same time. You can only select one of them for output at each time (wherein, the output terminals on the front panel provide higher output accuracy).

Tip

In CC output mode, when the load voltage is greater than the voltage setting value, the power supply will switch to CV output mode automatically. At this point, the output voltage equals the voltage setting value and the output current reduces proportionally.

Power Supply Series and Parallel Connections

Higher voltages can be provided when two or more insulated channels (the channels can be from a single power supply or multiple power supplies) are connected in series. Higher currents can be provided when two or more insulated channels (the channels can be from a single power supply or multiple power supplies) are connected in parallel.

Note:

- Only insulated channels can be connected in series or in parallel.
 - For a single power supply, CH1 and CH2/CH3 of DP832 can be connected in series or in parallel, but CH2 and CH3 cannot be connected in series or parallel; any two of the three channels of DP831 can be connected in series, CH1 and CH2/CH3 can be connected in parallel, but CH2 and CH3 cannot be connected in parallel; the two channels of DP822/DP821 can be connected in series or in parallel.
 - Channels (insulated channels) of different power supplies can be connected in series or parallel.
- In power series and parallel connections, the settings of the corresponding parameters must comply with the safety requirements.

Power Supply Series Connection

Higher voltages can be provided by connecting power supplies in series. In this case, the output voltage is the sum of the output voltages of all the channels. In power supply series connection, you need to set the same current setting value and overcurrent protection value for all the channels. Take the series connection of two channels as an example; the connection method is as shown in the figure below.

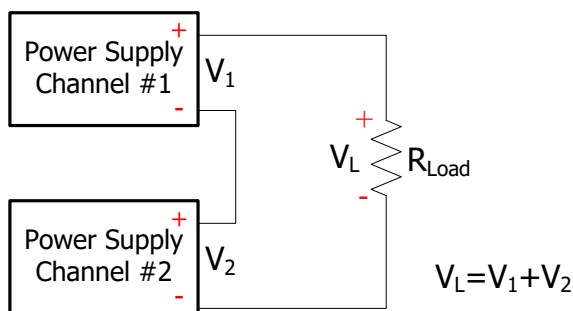

Operation Procedures:

- Connect the power supply and load as shown in the figure above. Pay attention to the polarity when making connections.

2. Set proper voltage, current and overcurrent protection value for each channel (all the channels in series connection should be working in constant voltage mode; you should set the same current setting values and the same overcurrent protection values for all the channels) by referring to "**Constant Voltage Output**". Turn on the output of each channel.

Note: Make sure that all the channels in series connection are working in constant voltage mode. If one of the channels is working in constant current mode, the other channels will enter critical state in which their outputs are unpredictable.

Power Supply Parallel Connection

High currents can be provided by connecting power supplies in parallel. In this case, the output current is the sum of the output currents of all the channels. In power supply parallel connection, you can set the parameters of each power supply. Take the parallel connection of two channels as an example; the connection method is as shown in the figure below.

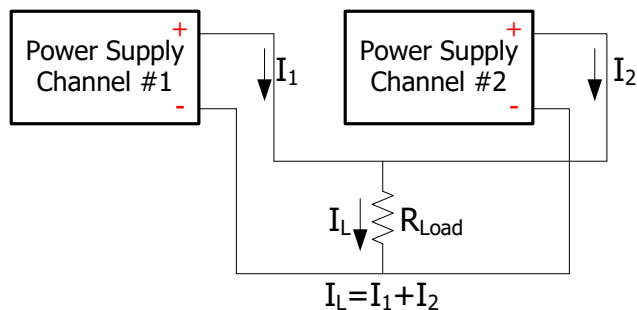

Operation Procedures:

1. Connect the power supply and load as shown in the figure above. Pay attention to the polarity when making connections.
2. Set proper parameters for each channel (all the channels can work in constant voltage or constant current mode) by referring to "**Constant Voltage Output**" and "**Constant Current Output**". Turn on the output of each channel.

Note: All the channels can work in constant voltage or constant current mode according to the actual need of the load.

Track Function

The track function is usually used to provide symmetric voltage for the operation amplifier or other circuit. For DP800 series power supply, the specified channels of the following models support the track function.

DP832: CH1, CH2

DP831: CH2, CH3

For channels that support the track function, you can set the tracking states of the voltage setting value and output on/off state respectively according to your need.

To Enable the Track Function

Press **Utility** → **System** → **Track Set** → **Track** to switch between "Synchronous" and "Independent".

- **Independent:** for two channels (the channels should be of the same instrument) that support the track function, the status of the track function of the other channel will not be affected when the track function of a channel is enabled or disabled.
- **Synchronous:** for two channels (the channels should be of the same instrument) that support the track function, the track function of the other channel will be enabled or disabled at the same time when the track function of a channel is enabled or disabled.

Tip

- When "Independent" is selected, users can enable or disable the track function of a single channel freely.
- When "Synchronous" is selected, users can quickly enable or disable the track functions of the two channels at the same time.

For channels (the channels should be of the same instrument) that support the track function, the tracking status of the channel voltage setting values is related to the number of channels of which the track functions are enabled.

- If only the track function of a single channel is enabled, the voltage setting value of the other channel will change accordingly when the voltage setting value of this channel is modified. At this point, the voltage setting value of the channel of which the track function is not enabled cannot be set and can only change with that of the channel of which the track function is enabled.
- If the track functions of the two channels are both enabled, the voltage setting value of the other channel will change accordingly when the voltage setting value of a channel is modified. At this point, the voltage setting values of both of the two channels can be set.

Tip

The track function only tracks the voltage setting value and the actual output voltage will not be affected.

You can perform the following operations according to your need.

1. Only enable the track function of a single channel and track the voltage setting value

The operation procedures are as follows (in this example, only the track function of CH1 of DP832 is enabled).

- Select the "Independent" tracking mode
Press **Utility** → **System** → **Track Set** → **Track** to select "Independent".
- Enable the track function of CH1
Select CH1 and press **Track** to select "On". At this point, the track function of CH1 is enabled and the tracking status icon  is displayed between the CH1 and CH2 areas in the user interface.
- Disable the track function of CH2 (ignore this step if the track function of CH2 is currently disabled)
Select CH2 and press **Track** to select "Off". At this point, the track function of CH2 is disabled.
- Track the voltage setting value
Select CH1, press **Voltage** and set the desired voltage. At this point, the voltage of CH2 changes accordingly. For example, set the voltage of CH1 to +5V; the voltage of CH2 will change to +5V automatically.

Note: At this point, the voltage setting value of CH2 cannot be set and can only change with that of CH1.

2. Enable the track functions of both of the two channels and track the voltage setting value

First, you can enable the track functions of the two channels using any of the following methods (take DP832 as an example).

Method 1

- Select the "Synchronous" tracking mode
Press **Utility** → **System** → **Track Set** → **Track** to select "Synchronous".
- Enable the track functions of CH1 and CH2 at the same time
Select CH1 or CH2, press **Track** and select "On". At this point, the track functions of CH1 and CH2 are both enabled. The tracking status icon  is

displayed between the CH1 and CH2 areas in the user interface.

Method 2

- Select the "Independent" tracking mode
Press **Utility** → **System** → **Track Set** → **Track** to select "Independent".
- Enable the track functions of CH1 and CH2
Select CH1 and press **Track** to select "On". At this point, the track function of CH1 is enabled and the tracking status icon  is displayed between the CH1 and CH2 areas in the user interface. Use the same method to enable the track function of CH2.

Then, select CH1 or CH2 and press **Voltage** and set the desired voltage. At this point, the voltage setting value of the other channel changes accordingly. For example, set the voltage of CH1 to +5V; the voltage of CH2 will change to +5V automatically.

Note: At this point, both of the voltage setting values of CH1 and CH2 can be set.

To Track the On/Off Status of the Channel Output

Press **Utility** → **System** → **Track Set** → **On/Off** to select "Enable" or "Disable".

- **Disable:** the output status of the other channel will not be affected when the output of a channel is turned on or off.
- **Enable:** for channels (the channels should be of the same instrument) that support the track function, the tracking status of the on/off status of the channel output is related to the number of channels of which the track functions are enabled.
 - If only the track function of a single channel is enabled (please refer to "**To Enable the Track Function**"), the output of the other channel will be turned on or off at the same time when the output of this channel is turned on or off. At this point, the output status of the channel of which the track function is not enabled cannot be set and can only change with that of the channel of which the track function is enabled.
 - If the track functions of the two channels are both enabled (please refer to "**To Enable the Track Function**"), the output of the other channel will be turned on or off at the same time when the output of a channel is turned on or off. At this point, the output status of both of the two channels can be set.

Sense Working Mode

When the output current of the power supply is high, the voltage drop on the load lead cannot be ignored. To ensure that the load can acquire the correct voltage drop, CH2 of DP822/DP821 and DP813/DP811 (both provide 10A output current) provide the Sense (remote sense) working mode. In this mode, the instrument detects the voltage at the load terminal instead of the voltage at the output terminal of the power supply; in this way, the instrument can automatically compensate for the voltage drop caused by the load lead to ensure that the power supply output value set by users is consistent with the voltage acquired by the load.

The Sense connecting method on the front panel is as shown in the figure below.

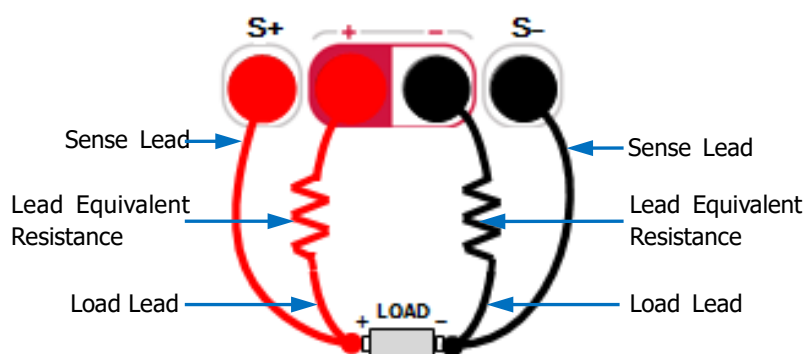

Operation Procedures:

1. Connect the channel output terminals and Sense terminals on the front panel of the instrument to the two ends of the load respectively, as shown in the figure above. Pay attention to the polarity when making connections.
2. For DP822/DP821: after you select CH2 (5V/16A for DP822; 8V/10A for DP821), press **Sense** to turn on the Sense function.
For DP813/DP811: after you select the desired range, press **Sense** turn on the Sense function.

Tip:

- When the output current is high, to acquire the best output characteristics, the load leads should be as short as possible and it is recommended that you twist the load leads together.
- Twisted pairs are recommended for the Sense leads and do not twist the Sense leads and load leads together.

In addition, the output interface on the rear panel of DP813/DP811 can also be used

for the Sense working mode. The Sense connecting method on the rear panel is as shown in the figure below.

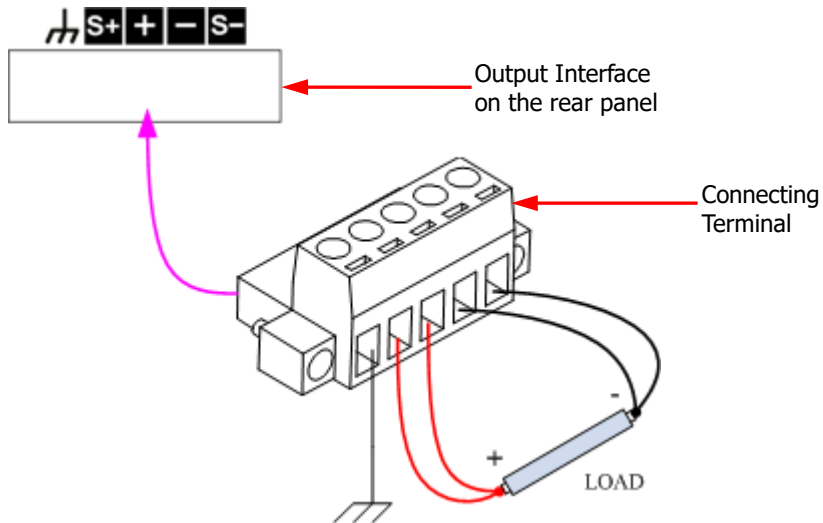

Operation Procedures:

1. Connect the load to the corresponding position on the connecting terminal correctly as shown in the figure above. Pay attention to the polarity when making connections.
2. Insert the connecting terminal into the output interface on the rear panel of the instrument correctly. Pay attention to the corresponding relations of the connecting terminal and the output interface.
3. After selecting the desired range, press **Sense** to turn on the Sense function.

Note: The output terminals on the front panel and the output interface on the rear panel cannot be used for the Sense mode at the same time. You can only select one of them for the Sense function at each time (wherein, the output terminals on the front panel provide higher output accuracy).

Timer and Delayer

DP800 provides the timer and delayer functions.

When the timer is enabled, the instrument outputs the preset voltage and current values (at most 2048 groups). Users can set the number of output groups of the timer as well as the voltage, current and timing time of each group. Besides, the instrument provides various built-in output templates and users can select and edit the templet as well as create timer parameters based on the templet. The instrument will output according to the parameters currently created.

When the delayer is enabled, the instrument enables or disables the output according to the preset state and delay time (at most 2048 groups). Users can set the number of output groups of the delayer as well as the state and delay time of each group.

Users can store the edited timer parameters (timer file, with the suffix ".RTF") and delayer parameters (delay file, with the suffix ".RDF") in internal or external memory and recall them when required.

Press **Timer** (the backlight turns on) to open the timer and delayer interface (as shown in Figure 2-1). The function of each menu key is as follows.

1. **Timer Set:** open the timer parameter setting interface and set the timer parameters;
2. **Timer:** turn on or off the timer;
3. **Delay Set:** open the delayer parameter setting interface and set the delayer parameters;
4. **Delayer:** turn on or off the delayer.

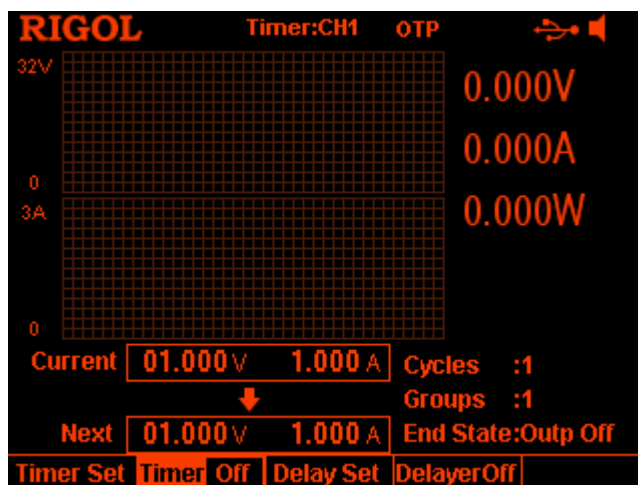

Figure 2-1 Timer and Delayer Interface

Tip
The timer function and delayer function are mutually exclusive. When the timer is enabled, **Delayer** is grayed out and disabled; when the delayer is enabled, **Timer** is grayed out and disabled.

To Set the Timer Parameters

Press **Timer** → **Timer Set** to enter the timer parameter setting interface as shown in the figure below. The channel currently selected is displayed in the status bar. You can press the channel selection keys on the front panel to switch the channel currently selected. This interface provides timer parameter preview; users can view the values on the current page of the timer parameter list (the horizontal axis denotes time and the vertical axis denotes voltage and current).

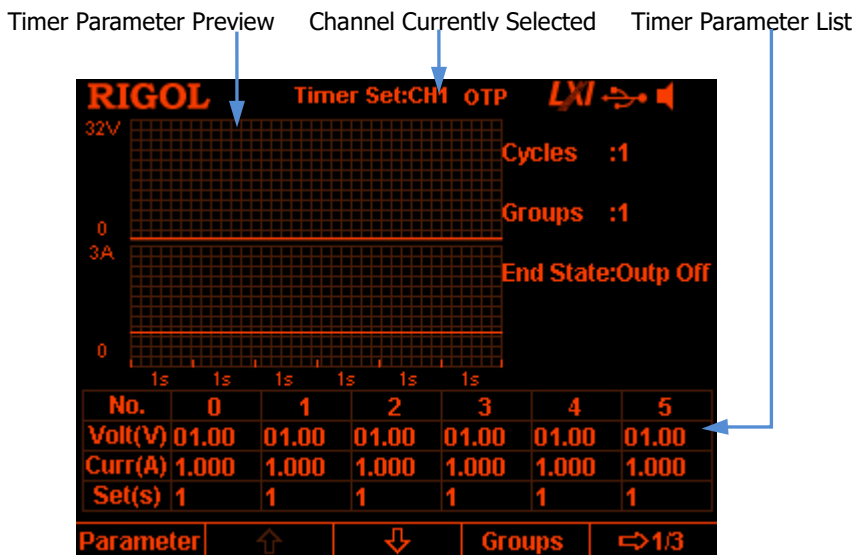

Figure 2-2 Timer Parameter Setting Interface

You can set the timer parameters in the timer parameter setting interface following the steps below.

1. To Set the Number of Output Groups
2. To Set the Number of Cycles
3. To Set the End State
4. To Edit the Timer Parameters
5. To Save and Read the Timer File

To Set the Number of Output Groups

The number of output groups is defined as the number of groups of preset voltage and current values that the power supply outputs in each cycle. Press **Groups** and use the numeric keyboard or the left/right arrow key and knob to input the desired value. The range is from 1 to 2048.

To Set the Number of Cycles

The number of cycles is defined as the number of times that the instrument performs timing output according to the preset voltage and current. Press **Cycles** to set the number of cycles to "Infinite" or use the numeric keyboard or the left/right arrow key and knob to input the desired value. The range is from 1 to 99999.

Tip

- The total number of groups in timing output = the number of output groups* the number of cycles
- The power supply will terminate the timer function when the total number of groups of outputs is finished. At this point, the state of the power supply depends on the setting in "**To Set the End State**".

To Set the End State

The end state refers to the state of the instrument after it finishes outputting the total number of groups of voltage and current values when the number of cycles is a specified value. Press **End State** to select "Outp Off" or "Last".



- Outp Off: the instrument turns off the output automatically after finishing the output.
- Last: the instrument stops at the output state of the last group after finishing the output.

Note: When the number of cycles is set to "Infinite", the end state is invalid.

To Edit the Timer Parameters

You can edit the timer parameters manually or using the built-in templet.

To Edit the Timer Parameters Manually

You need to set **P** groups (No.0 to No.(P-1)) of timer parameters; wherein, **P** is the number of output groups currently set. Only 6 groups of parameters can be displayed on each page of the timer parameter list and you can press  or  to view and set the parameters of the other groups. This interface provides timer parameter preview; users can view the values on the current page of the timer parameter list (the horizontal axis represents time and the vertical axis represents voltage and current).

1. Press **Parameter** and use the numeric keyboard, the left/right arrow key or the knob to select the specified number (No.) in the timer parameter list.
2. Use the up/down arrow key to select the voltage (V), current (C) and time (s) of the current group respectively and use the numeric keyboard or the left/right arrow key and knob to input the desired value.
3. Use the same method to set the parameters of the other groups.

To Edit the Timer Parameters using Templet

The instrument provides various built-in output templets. Users can select the desired templet, edit the timer parameters using the templet and create waveform. The instrument will output according to the waveform currently created.

Press **Templet** to open the templet editing menu. You can edit the timer parameters according to the steps below.

1. Select the editing object
2. Select the templet
3. Edit the timer parameters
4. Construct the output waveform

1. Select the editing object

Press **Edit Obj** to select "Voltage" or "Current".

- Voltage: when it is selected, the interface displays the voltage preview and you can set all the groups to output a fixed current. Press **Current** and use the numeric keyboard or the left/right arrow key and knob to set the current value.
- Current: when it is selected, the interface displays the current preview and you can set all the groups to output a fixed voltage. Press **Voltage** and use the numeric keyboard or the left/right arrow key and knob to set the voltage value.

2. Select the templet

Press **Type** to select the desired templet, including Sine, Pulse, Ramp, Stair Up, Stair Dn, StairUpDn, Exp Rise and Exp Fall.

- **Sine**

The Sine waveform is as shown in the figure below. The instrument determines the Sine amplitude according to the maximum and minimum currently set and determines the Sine period according to the total number of points (denoted by **P**) and the time interval currently set, thus determining the Sine waveform. When creating parameters, the instrument draws **P** values from the preset Sine waveform according to the current time interval.

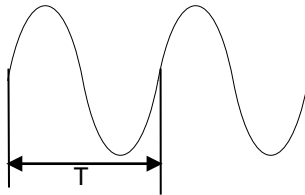

- **Pulse**

The Pulse waveform is as shown in the figure below. The timer parameters created from Pulse waveform only contain two groups of data. The first group: the amplitude (voltage or current) is determined by the high level set; the time equals the pulse width (**t**) currently set. The second group: the amplitude (voltage or current) is determined by the low level set; the time equals the period currently set minus the pulse width currently set (**T-t**).

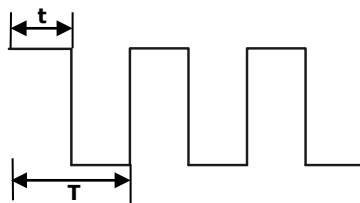
**Tip**

When Pulse is selected, if you want to output more than 2 groups of timer parameters, you can output the timer parameters created from the Pulse templet repeatedly by increasing the number of cycles.

- **Ramp**

The Ramp waveform is as shown in the figure below. The instrument determines the amplitude of the Ramp according to the maximum and minimum currently set, determines the period according to the total number of points (denoted by **P**) and the time interval currently set and determines the Ramp waveform according to the symmetry (denoted by **Sym**) currently set. When creating parameters, the instrument draws **int(P*S_{ym})**^[1] values from the rising edge of the preset Ramp waveform at the same time interval and draws **P-int(P*S_{ym})** values from the falling edge of the preset Ramp waveform at the same time interval. The timing time is determined by the time interval currently set.

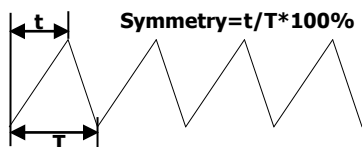

Note^[1]: **int(P*S_{ym})** refers to rounding **P*S_{ym}** (discard the decimal part).

- **Stair Up**

The Stair Up waveform is as shown in the figure below. The instrument determines the Stair Up waveform according to the maximum (denoted by **MAX**), minimum (denoted by **MIN**), total number of points (denoted by **P**, **P** ≥ 10) and time interval currently set and creates **P** parameters from **MIN** to **MAX** at the step of **(MAX-MIN)/(P-1)**. The timing time is determined by the time interval currently set.

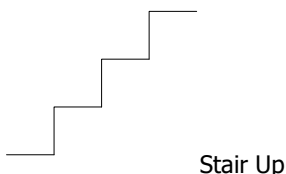

- **Stair Dn**

The Stair Dn waveform is as shown in the figure below. The instrument determines the Stair Dn waveform according to the maximum (denoted by **MAX**), minimum (denoted by **MIN**), total number of points (denoted by **P**) and time interval currently set and creates **P** parameters from **MIN** to **MAX** at the step of **(MAX-MIN)/(P-1)**. The timing time is determined by the time interval currently set.

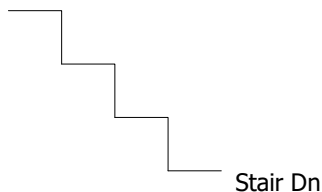

- **StairUpDn**

The StairUpDn waveform is as shown in the figure below. The instrument determines the StairUpDn waveform according to the maximum (denoted by **MAX**), minimum (denoted by **MIN**), total number of points (denoted by **P**) and time interval currently set and creates **P** parameters. When **P** is an odd number, the value increase from **MIN** to **MAX** at the step of $(\mathbf{MAX-MIN})/\mathbf{int(P/2)}$ ^[1] and then reduces to **MIN** at the same step. When **P** is an even number, the value increases from **MIN** to **MAX** at the step of $(\mathbf{MAX-MIN})/\{\mathbf{int(P/2)-1}\}$ and then reduces to **MIN** at the step of $(\mathbf{MAX-MIN})/\mathbf{int(P/2)}$. The timing time is determined by the time interval currently set.

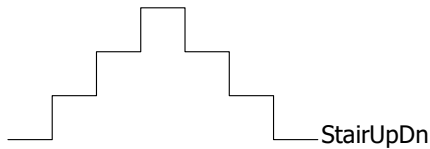

Note^[1]: $\mathbf{int(P/2)}$ indicates rounding **P/2** (discard the decimal part).

- **Exp Rise**

The Exp Rise waveform is as shown in the figure below. The instrument determines the Exp Rise waveform according to the maximum (denoted by **MAX**), minimum (denoted by **MIN**), total number of points (denoted by **P**), time interval and rise index (denoted by **RiseIndex**) currently set. The waveform function is $(\mathbf{MAX-MIN}) * (1 - e^{-i * \mathbf{RiseIndex}/\mathbf{P}})$; wherein, **i** is independent variable and creates **P** groups of parameters from 0 to **(P-1)**. The timing time is determined by the time interval currently set.

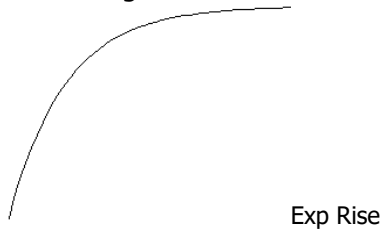

- **Exp Fall**

The Exp Fall waveform is as shown in the figure below. The instrument determines the Exp Fall waveform according to the maximum (denoted by **MAX**), minimum (denoted by **MIN**), total number of points (denoted by **P**), time interval and fall index (denoted by **FallIndex**) currently set. The waveform function is $(MAX-MIN)*e^{-i*FallIndex/P}$; wherein, **i** is independent variable and creates **P** groups of parameters from 0 to **(P-1)**. The timing time is determined by the time interval currently set.

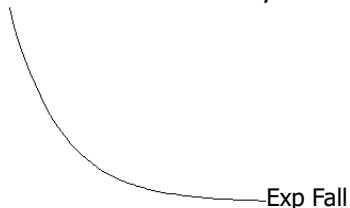

Note

When the templet currently selected is Exp Rise or Exp Fall, the timer parameters created cannot reach the maximum or minimum due to the characteristic of the exponential function. The range of the timer parameters created is related to the rise index or fall index currently set. The larger the rise index or fall index is, the larger the range of the timer parameters will be, as shown in the figures below (maximum=8, minimum=0, total number of points=100, rise indexes/fall indexes are 1, 4, 7 and 10 respectively).

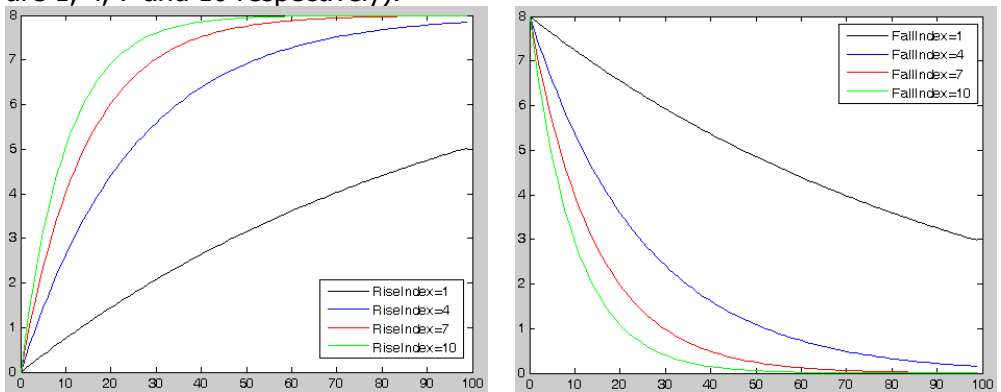

3. Edit the timer parameters

For different templets, the timer parameters to be set are different as shown in Table 2-1.

Table 2-1 Timer parameters (templet)

Templet	Parameter
Sine	Max Value, Min Value, Points, Interval, Inverted
Pulse	Hi Level, Lo Level, Width, Period, Inverted
Ramp	Max Value, Min Value, Points, Interval, Symmetry, Inverted
Stair Up	Max Value, Min Value, Points, Interval
Stair Dn	Max Value, Min Value, Points, Interval
StairUpDn	Max Value, Min Value, Points, Interval
Exp Rise	Max Value, Min Value, Points, Interval, Rise Index
Exp Fall	Max Value, Min Value, Points, Interval, Fall Index

- **Max Value**
Set the maximum voltage or current of the templet currently selected. The range is related to the channel currently selected. It should be greater than or equal to the minimum value currently set.
- **Min Value**
Set the minimum voltage or current of the templet currently selected. The range is related to the channel currently selected. It should be lower than or equal to the maximum value currently set.
- **Points**
Set the total number of points (namely the number of output groups in the timer parameters) of the templet currently selected. The range is from 10 to 2048.

When the total number of points (denoted by **P**) and the current number of output groups (denoted by **G**) are different, the number of output groups will change to **P** automatically after output waveform is created using the templet.

- **Interval**
Set the time interval between the points (the time required for the instrument to output each group of timer parameters) of the templet currently selected. The range is from 1s to 99999s.
- **Inverted**
When the templet currently selected is Sine, Pulse or Ramp, if invert is enabled, the instrument will first turn the preset waveform upside down and then create the output waveform.

- **Hi Level**
When the templet currently selected is Pulse, set the high level of the Pulse and the range is related to the channel currently selected. It should be greater than or equal to the low level currently set.
- **Lo Level**
When the templet currently selected is Pulse, set the low level of the Pulse and the range is related to the channel currently selected. The low level should be lower than or equal to the high level currently set.
- **Width**
When the templet currently selected is Pulse, set the positive pulse width of the Pulse (namely the duration of high level within a period). The range is from 1s to 99998s.

Tip

The actual range of the positive pulse width is related to the period currently set. The actual range is from 1s to (Period-1s).

- **Period**
When the templet currently selected is Pulse, set the period of the Pulse and the range is from 2s to 99999s.

Tip

The actual range of the period is related to the positive pulse width currently set. The actual range is from (Positive Pulse Width+1s) to 99999s.

- **Symmetry**
When the templet currently selected is Ramp, set the symmetry of the Ramp (namely the ratio of the duration of the rising edge within a period to the whole period) and the range is from 0% to 100%.
- **Rise Index**
When the templet currently selected is Exp Rise, set the rise index of the Exp Rise and the range is from 0 to 10.
- **Fall Index**
When the templet currently selected is Exp Fall, set the fall index of the Exp Fall and the range is from 0 to 10.

4. Construct the output waveform

After editing the timer parameters (templet), press **Construct** to construct the output waveform. The timer parameters corresponding to the output waveform constructed are displayed in the timer parameter list as shown in Figure 2-2.

To Save and Read the Timer File

You can store the timer parameters edited manually or using the templet in internal or external memory and recall them when required.

1. Save

After editing the timer parameters, press **Save** to enter the store and recall interface. The file type is fixed at "*.rtf" and please save the timer file according to the introduction in "**Save**".

2. Read

Press **Read** to enter the store and recall interface. The file type is fixed at "*.rtf" and please read the desired file according to the introduction in "**Read**". Users can edit the timer file read.

To Enable the Timer

After setting the timer parameters, return to the timer and delayer interface (as shown in Figure 2-1). Press **Timer** to enable the timing output. The timing output interface is as shown in the figure below.

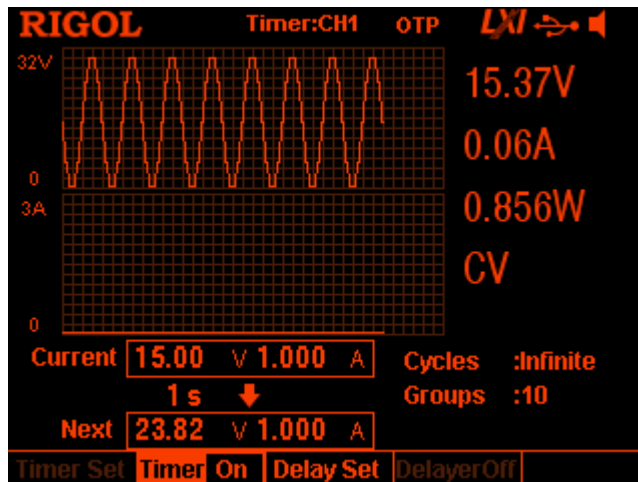

Figure 2-3 Timing Output Interface

Tip

- Enabling the timer will change the output value of the channel; make sure that the change in the output value will not affect the device connected to the power supply before enabling the timer.
- The timing output is valid only when both the timer and the channel output are turned on.
- When the timer is enabled, the timer parameters cannot be modified and **Delayer** is grayed out and disabled.

To Set the Delay Parameters

Press **Timer** → **Delay Set** to enter the delay parameter setting interface as shown in the figure below. The channel currently selected is displayed in the status bar. Press the channel selection keys on the front panel to switch the channel currently selected. This interface provides delay parameter preview. Users can view the values on the current page of the delay parameter list (high level indicates turning on the output and low level indicates turning off the output).

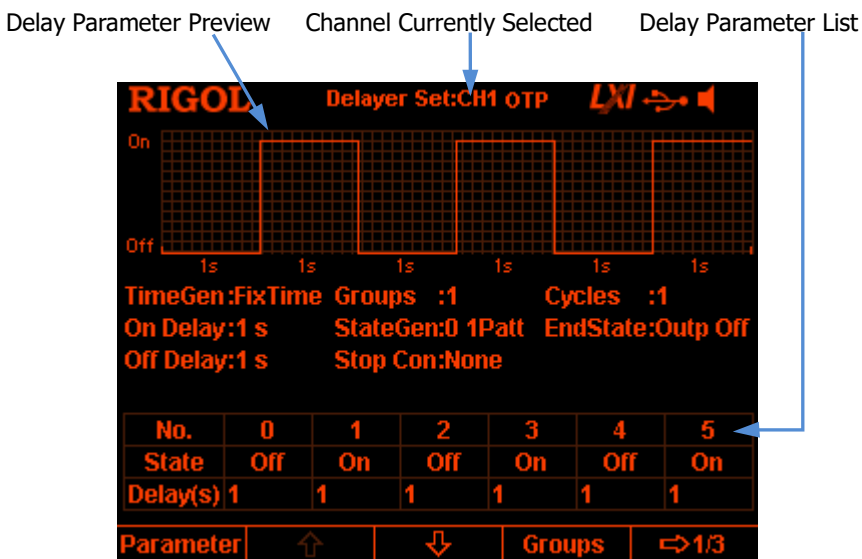

Figure 2-4 Delay Parameter Setting Interface

You can set the delay parameters in the delay parameter setting interface following the steps below.

1. To Set the Number of Output Groups
2. To Set the Number of Cycles
3. To Set the End State
4. To Edit the Delay Parameters
5. To Set the Stop Condition
6. To Save and Read the Delay File

To Set the Number of Output Groups

The number of output groups refers to the number of times that the instrument turns on or off the output according to the preset state. Press **Groups**; use the numeric keyboard or the left/right arrow key and knob to input the desired value. The range is from 1 to 2048.

To Set the Number of Cycles

The number of cycles refers to the number of times that the instrument performs delay output according to the preset state. Press **Cycles** to set the number of cycles to "Infinite" or use the numeric keyboard or the left/right arrow key and knob to input the desired value. The range is from 1 to 99999.

Tip

- The total number of groups in delay output = the number of output groups*the number of cycles
- The power supply will terminate the delay function when the instrument detects the state that meets the condition set in "**To Set the Stop Condition**" or when the total number of groups of delay outputs is finished. At this point, the state of the power supply depends on the setting in "**To Set the End State**".

To Set the End State



The end state refers to the state of the instrument when the delay function is terminated. Press **End State** to select "Outp On", "Outp Off" or "Last".

- Outp On: the instrument turns on the output automatically.
- Outp Off: the instrument turns off the output automatically.
- Last: the instrument stops at the output state of the last group.

To Edit the Delay Parameters

You can edit the delay parameters manually or generate the delay parameters automatically using the built-in pattern and built-in method.

To Edit the Delay Parameters Manually

You need to set **P** groups (No.0 to No.(P-1)) of delay parameters; wherein, **P** is the number of output groups currently set. Only 6 groups of parameters can be displayed on each page of the delayer parameter list and you can press  or  to view and set the parameters of the other groups. This interface provides delay parameter preview and users can view the values on the current page of the delay parameter list (high level indicates turning on the output and low level indicates turning off the output).

1. Press **Parameter** and use the numeric keyboard or the left/right arrow key or the knob to select the specified number (No.) in the delay parameter list.

2. Use the up/down arrow key to select the state (State) and time (Delay) of the current group respectively.
When state (State) is selected, press **OK** to switch to the desired state; when time (Delay) is selected, use the numeric keyboard or the left/right arrow key and knob to input the desired value.
3. Use the same method to set the parameters of the other groups.

To Generate the Delay Parameters Automatically

The instrument provides various kinds of built-in patterns and built-in time sequence generation algorithms used to automatically generate delay on/off state and time sequence respectively. Users can select the state generation mode and time sequence generation mode and the instrument will generate the delay parameters automatically according to the current settings.

1. Select the state generation mode

Press **State Gen** → **0 1 Patt (1 0 Patt)** to select "0 1 Patt" ("1 0 Patt").

- 0 1 Patt: the state is set to "Off" and "On" alternately.
- 1 0 Patt: the state is set to "On" and "Off" alternately.

The instrument will generate the on/off state automatically according to the current setting and the length is the number of output groups currently set.

2. Select the time generation mode

1) Select the generation method

Press **Time Gen** → **Method** to select "FixTime", "Increase" or "Decline".

- FixTime
Users set the output on delay time (on delay, namely the duration when the output status is "On") and the output off delay time (off delay, namely the duration when the output status is "Off").
- Increase
Generate the on/off delay time by increasing from the time base value at the specified step. Users can set the time base value and step.
- Decline
Generate the on/off delay time by declining from the time base value at the specified step. Users can set the time base value and step.

2) Set the on delay/off delay

When the time generation method is "FixTime", users need to set the output on delay time and output off delay time.

Press **Time Gen** → **On Delay (Off Delay)**; use the numeric keyboard or the left/right arrow key and knob to input the desired value. The ranges of on delay and off delay are both from 1s to 99999s.

- 3) Set the time base value and step
When the time generation method is "Increase" or "Decline", users need to set the time base value and step.

Press **Time Gen** → **Base Val (Step)**; use the numeric keyboard or the left/right arrow key and knob to input the desired value. The minimum time base value and step are both 1s and the two fulfills the relation: time base value + number of output groups*step ≤ 999999s.

To Set the Stop Condition

The instrument monitors the output voltage, current and power during delay output. You can set a stop condition and the instrument terminates the delay function (no matter whether the total number of groups of delay outputs are finished) when state that fulfills this condition is detected. At this point, the state of the instrument is determined by the setting in "**To Set the End State**".

Press **Stop Con** to set the stop condition to "None", "< Voltage", "> Voltage", "< Current", "> Current", "< Power" or "> Power". After selecting the desired condition, use the numeric keyboard or the left/right arrow key and knob to input the desired value (you do not need to set this parameter when the stop condition is set to "None").

To Save and Read the Delay File

You can save the delay parameters edited manually or generated automatically in internal or external memory and recall them when required.

1. Save

After finishing editing the delay parameters, press **Save** to enter the store and recall interface. The file type is fixed at "*.rdf" and please save the file according to the introduction in "**Save**".

2. Read

Press **Read** to enter the store and recall interface. The file type is fixed at "*.rdf" and please read the desired file according to the introduction in "**Read**". Users can edit the delay file read.

To Enable the Delayer

After setting the delay parameters, return to the timer and delayer interface (as shown in Figure 2-1). Press **Delayer** to enable the delay output. The delay output interface is as shown in the figure below.

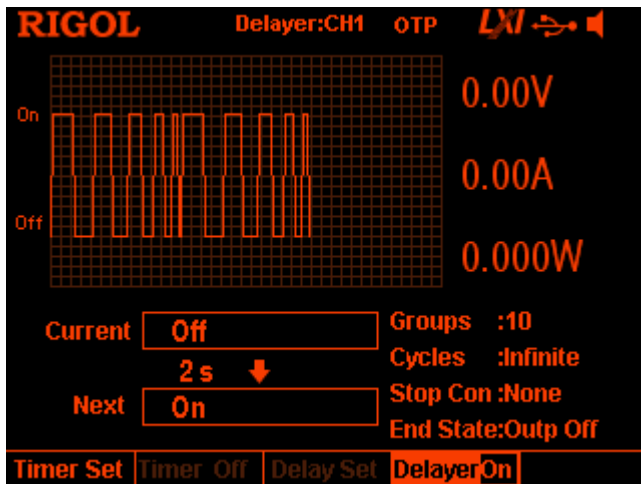



Figure 2-5 Delay Output Interface

Tip

- Enabling the delayer will change the output state of the channel. Please make sure that the change of the output state will not affect the devices connected to the power supply before enabling the delayer.
- When the delayer is enabled, the delayer parameters cannot be modified and **Timer** is grayed out and disabled.

Advanced Functions

DP800 provides various advanced functions, including the recorder, analyzer (option^[1]), monitor (option) and trigger (option). Press  to open the advanced function setting interface.

1. **Recorder:** record the output state of each channel and store the record file.
2. **Analyzer:** analyze the record file saved.
3. **Monitor:** monitor the output of each channel and turn off the output, display the corresponding prompt message or sound the beeper when the monitor condition is met.
4. **Trigger:** the rear panel provides a digital I/O interface which supports trigger input and trigger output.
 - **Trigger Input:** the data lines of the digital I/O interface receive external trigger signal. The source under control (namely the output channel) turns on the output, turns off the output or inverts the output state when the preset trigger condition is met.
 - **Trigger Output:** the data lines of the digital I/O interface output the level or square signal when the output of the control source (namely the output channel) meets the preset trigger condition.

Note^[1]: For function marked with "option", you need to order the corresponding option according to the order number provided in "**Appendix A: Accessories and Options**" in this manual and install the option correctly (refer to "**Options**") before using the function.

Recorder

When the recorder is enabled, users can record the current state of the instrument and if an analyzer is installed, users can also analyze the file recorded.

Press  → **Recorder** to open the recorder setting interface. You can turn on or off the recorder function, set the record period and select the store destination.

Note: When the recorder is turned on, the record period and storage destination cannot be set. Therefore, please set the record period and storage destination before turning on the recorder.

You can record and save the record file following the steps below.

1. Set the record period

The record period is the time interval at which the instrument samples and records the output of each channel when the recorder is turned on. Press **Period** and use the numeric keyboard or the left/right arrow key and knob to set the desired value. The range is from 1s to 99999s and the default is 1s.

2. Set the storage destination

Press **Dest** to enter the store and recall interface and the file type is fixed at "*.rof". After selecting the desired destination, press **Save** and input the desired filename (for the detailed operations, refer to the introduction in "**Save**"); then, press **OK**.

Note:

- You can store the record file in the internal or external memory. In one record operation, the recorder can record up to 2048 points when the internal memory is selected or 614400 points when the external memory is selected.
- When the recorder is turned off, the instrument will store the record file with the specified filename to the specified destination according to the settings in this step.

3. Turn on or off the recorder

- Press **Switch** to turn on the recorder. The instrument samples and records the output of each channel by using the current record period as the time interval.
- Press **Switch** to turn off the recorder. When the recorder is turned off, the current record is finished; press **OK** and the instrument will store the recorded file to the specified destination according to the settings in step 2.

Note:

- During the record, make sure that the output of each channel is enabled; otherwise, the record data will be 0.
- You can only store the record file when at least a single point is recorded.

Analyzer (option)

The analyzer can analyze the file recorded and provides the analysis results of the channel voltage, current and power, such as the average, VAR and range.

Press  → **Analyzer** to open the analyzer setting interface. You can open the record file stored, set the analyzer parameters, execute analysis and view the analysis results.

You can analyze the stored record file and view the analysis results following the steps below.

1. Open the record file

Press **Open File** to enter the store and recall interface and the file type is fixed at "*.rof". Select the desired record file and press **Read**.

At this point, the current time and start time are both the **record period** of the file opened. When the **number of groups** of the file opened is less than or equal to 2048, the end time is the maximum record time (the **number of groups***the **record period** of the record file opened) of the record file opened; when the **number of groups** of the file opened is greater than 2048, the end time is the **record period** of the file opened*2048.

Note: The following operations are valid only when valid record file is opened.

2. Set the analysis parameters

● Start Time

Press **Start Time** and use the numeric keyboard or the left/right arrow key and knob to set the start time of the record file analysis. The range is from the **record period** of the file opened to the current **end time**.

● End Time

Press **End Time** and use the numeric keyboard or the left/right arrow key and knob to set the end time of the record file analysis. When the **number of groups** of the file opened is less than or equal to 2048, the range is from the **start time** to the maximum record time (the **number of groups***the **record period**) of the file opened; when the **number of groups** of the file opened is greater than 2048, the range is from the **start time** to the **record period** of the file opened*2048.

3. Execute the analysis

Press **Analyze** and the instrument will start to analyze the record file opened according to the current setting. The analysis results include various statistic parameters of the channel voltage, current and power, such as the average, VAR and range.

4. View the analysis results

After the analysis is finished, you can view the analysis results according to your need.

- **Analysis object**

Press **Object** to select "Voltage", "Current" or "Power" and the corresponding analysis results will be displayed at the bottom of the screen.

Note: When "ALL" is selected, you can press the up/down arrow key to switch the current analysis object and view the corresponding analysis results.

- **Display type**

The data between the start time and end time in the record file currently opened will be displayed in figure or table form at the upper side of the screen.

Press **Disp Type** continuously to select figure or table display form.

Figure

Display the voltage, current or power (depend on the analysis object currently selected) corresponding to the current channel of the record file opened in figure form. Each group of measurement values of each object are connected in linear interpolation mode, clearly showing the variation tendency. At the same time, the data corresponding to the "Current Time" is displayed above the figure.

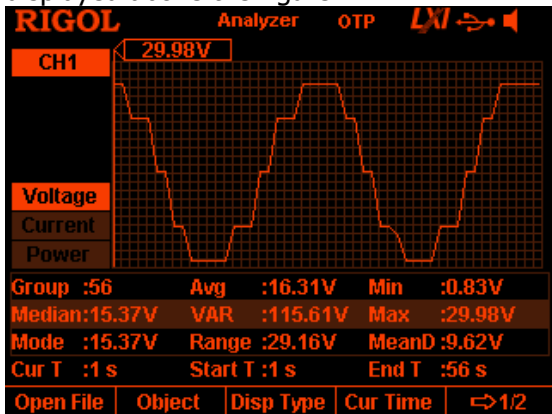

Tip

- You can view the analysis results of the specified channel by switching the current channel.
- You can set the analysis object to display the specified type of data (voltage, current or power) at the upper side of the screen.
- You can view the specified group of data by setting the "**Current Time**".

Table

Display each group of voltage, current and power of the current channel in the record file opened in table form.

RIGOL Analyzer OTP LXI				
CH1	Time	Voltage	Current	Power
	1 s	29.98V	0.06A	1.670W
	2 s	29.98V	0.06A	1.670W
	3 s	24.41V	0.06A	1.355W
	4 s	24.41V	0.06A	1.357W
	5 s	24.41V	0.08A	1.950W
	6 s	15.37V	0.06A	0.853W
	7 s	15.37V	0.06A	0.853W
Group	:56	Avg :16.31V	Min :0.83V	
Median	:15.37V	VAR :115.61V	Max :29.98V	
Mode	:15.37V	Range :29.16V	MeanD :9.62V	
Cur T	:1 s	Start T :1 s	End T :56 s	
Open File	Object	Disp Type	Cur Time	⇌ 1/2

Tip

- You can view the analysis results of the specified channel by switching the current channel.
- You can view the specified group of data by setting the "**Current Time**".

- **Current Time**

You can quickly locate each group of data of the record file opened between the start time and end time by setting the current time. If the current display mode is figure, the interface will locate the current data (the voltage, current or power corresponding to the "Current Time" is displayed above the figure) using a cursor line in the color corresponding to the current channel.

Press **Cur Time** and use the numeric keyboard or the left/right arrow key and knob to set the desired value. The range is from the **start time** to the **end time**.

Monitor (option)

The monitor can monitor the current output state of the instrument. When the user-defined monitor condition is met, the instrument executes the corresponding operation according to the setting in "**Stop Mode**".

Press  → **Monitor** to open the monitor setting interface. The status bar shows the channel currently selected. Press the channel selection keys on the front panel to switch the channel.

Note: The instrument can monitor the output states of multiple channels simultaneously.

You can set the monitor condition and turn on or off the monitor function following the steps below.

1. Monitor Condition

The monitor condition can be any logic combination of voltage, current and power and users can also set the voltage, current and power values.

Press **Condition** and use the arrow keys and  to set the desired monitor condition.

2. Voltage

Press **Voltage** and use the numeric keyboard or the left/right arrow key and knob to set the voltage in the monitor condition.

3. Current

Press **Current** and use the numeric keyboard or the left/right arrow key and knob to set the current in the monitor condition.

4. Power

Press **Power** and use the numeric keyboard or the left/right arrow key and knob to set the power in the monitor condition.

5. Stop Mode

When the channel output state meets the monitor condition set, the instrument will turn off the output, display the corresponding prompt message or sound the beeper according to the stop mode selected. The stop mode can be one or more of "Output Off", "Warning" and "Beeper".

Press **Stop Mode** and use the arrow keys to select the specified stop mode ("Output Off", "Warning" and "Beeper"); then, press  to enable or disable the stop mode selected.

6. Switch

Press **Switch** to turn on or off the monitor function.

Trigger (option)

The rear panel of DP800 provides a digital I/O interface which supports trigger input and trigger output.

- **Trigger Input:**
The data lines of the digital I/O interface receive external trigger signal. The source under control (namely the output channel) turns on the output, turns off the output or inverts the output state when the preset trigger condition is met.
- **Trigger Output:**
The data lines of the digital I/O interface output level or square signal when the output of the control source (namely the output channel) meets the preset trigger condition.

The 4 data lines of the digital I/O interface are mutually independent and can be used as trigger input or trigger output separately.

The trigger connections are as shown in the figure below.

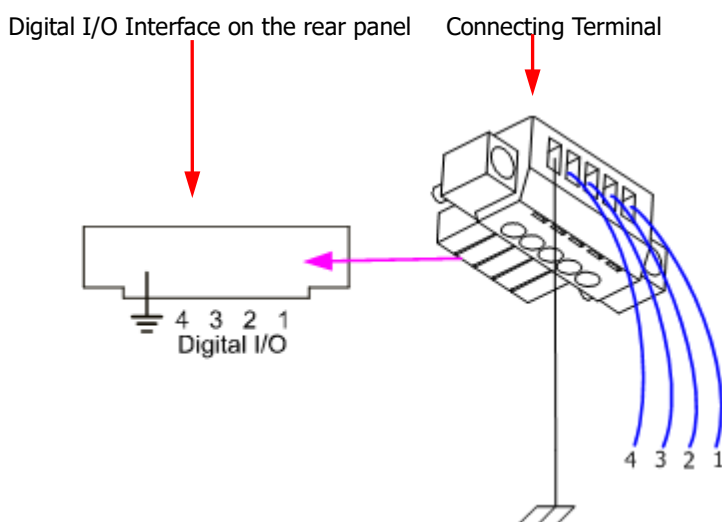

Operation Procedures:

1. Connect the cables to the connecting terminals according to the figure above (pay attention to the corresponding relations).
2. Insert the connecting terminals into the digital I/O interface on the rear panel (pay attention to the corresponding relations).

Press  → **Trigger** to open the trigger setting interface as shown in the figure below. Press **Trig** to select trigger input or trigger output and the corresponding setting interface is opened. The default is trigger input.

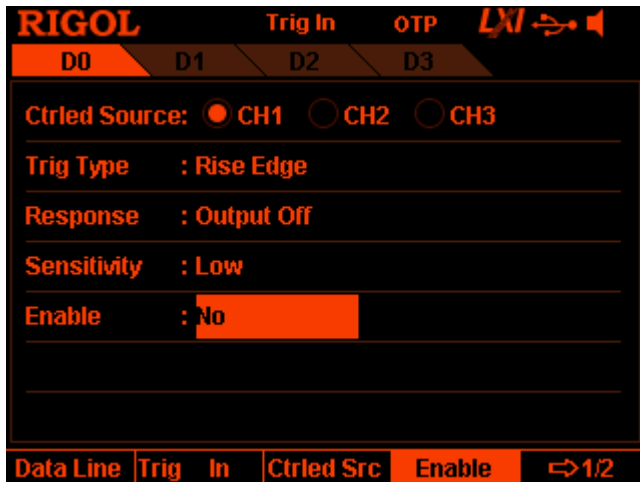

Figure 2-6 Trigger Setting Interface

Trigger Input

When signal that meets the current trigger type is input on the specified data line, the specified source under control will turn on the output, turn off the output or toggle the output state according to the setting in output response.

Press **...** → **Trigger** → **Trig** to select "In" and the trigger input setting interface is opened, as shown in Figure 2-6.

1. Data Line

Press **Data Line** to select D0, D1, D2 or D3 and the data line currently selected will be highlighted on the screen. Users can set the trigger conditions of the four data lines respectively.

2. Source under Control

Press **Ctrlled Src** to select one or more of CH1, CH2 and CH3 as the source under control.

3. Trigger Type

Press **Trig Type** to select to trigger on the rising edge, falling edge, high level or low level of the input signal.

Tip

For the input signal, high level is from 2.5V to 3.3V, low level is from 0V to 0.8V and noise tolerance is 0.4V.

4. Output Response

Press **Outp Resp** to set the output response type to "Output On", "Output Off"

or "Output Toggle".

- Output On: when the trigger condition is met, turn on the output of the channel currently selected as the source under control.
- Output Off: when the trigger condition is met, turn off the output of the channel currently selected as the source under control.
- Output Toggle: when the trigger condition is met, turn the waveform of the channel currently selected as the source under control upside down and then output the waveform.

5. Sensitivity

Press **Sensitivity** to set the sensitivity to high, middle or low. Selecting relatively lower trigger sensitivity can avoid mis-trigger at the noise.

6. Enable

Press **Enable** to enable or disable the trigger input function of the corresponding data line.

Trigger Output

When the output of the specified control source meets the trigger condition, the specified data line outputs level or square waveform according to the setting of the output signal.

Press  → **Trigger** → **Trig** to select "Out" and the trigger output setting interface is opened, as shown in the figure below.



Figure 2-7 Trigger Output Setting Interface

1. Data Line

Press **Data Line** to select D0, D1, D2 or D3 and the data line currently selected will be highlighted on the screen. Users can set the trigger conditions of the four data lines respectively.

2. Control Source

Press **Ctrl Src** to select any of CH1, CH2 and CH3 as the control source.

3. Trigger Condition

Press **Condition** to open the trigger condition setting interface and users can set the trigger condition of trigger output.

- **Outp Trig**: the instrument triggers when the output of the control source is turned on or off.
Press **Outp Trig** and use the up/down arrow key to select "Output Off" or "Output On".
- **Volt Trig**: the instrument triggers when the output voltage of the control source meets the voltage condition set.
Press **Volt Trig** and use the up/down arrow key to select ">", "<" or "="; use the numeric keyboard or the left/right arrow key and knob to set the voltage value.
- **Curr Trig**: the instrument triggers when the output current of the control source meets the current condition set.
Press **Curr Trig** and use the up/down arrow key to select ">", "<" or "="; use the numeric keyboard or the left/right arrow key and knob to set the current value.
- **PowerTrig**: the instrument triggers when the output power of the control source meets the power condition set.
Press **PowerTrig** and use the up/down arrow key to select ">", "<" or "="; use the numeric keyboard or the left/right arrow key and knob to set the power value.
- **Auto Trig**: when the trigger output is enabled, the instrument triggers automatically.

4. Output Signal

Press **Signal** to set the signal type of the trigger output to "Level" or "Square".

- **Level**: the output high level is from 2.6V to 3.5V and the output low level is from 0V to 0.4V.
- **Square**: press **Period** to set the square period and the range is from 100 μ s to 2.5s; press **Duty** to set the duty cycle of the square waveform and the range is from 10% to 90%.

5. Polarity

Press **Polarity** to set the polarity of the trigger output signal to "Positive" or "Negative".

- **Positive**: output the signal selected in **Signal** when the trigger condition is met.
- **Negative**: turn the signal selected in **Signal** upside down and then output the signal when the trigger condition is met.

6. Enable

Press **Enable** to enable or disable the trigger output function of the corresponding data line.

Display Setting

Press **Display** on the front panel to enter the interface as shown in the figure below. You can set the screen brightness, contrast, RGB luminance, display mode and display theme. Besides, you can also define the start-up interface.

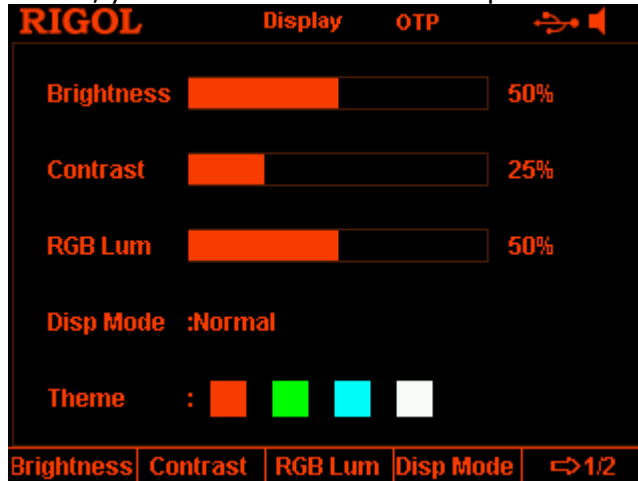

Figure 2-8 Display Setting Interface

Brightness

Press **Display** → **Brightness** and use the knob, left/right arrow key or numeric keyboard to set the brightness of the screen. The range is from 1% to 100% and the default is 50%. This setting is stored in the non-volatile memory and will not be affected by factory reset.

Contrast

Press **Display** → **Contrast** and use the knob, left/right arrow key or numeric keyboard to set the contrast of the screen. The range is from 1% to 100% and the default is 25%. This setting is stored in the non-volatile memory and will not be affected by factory reset.

RGB Luminance

Press **Display** → **RGB Lum** and use the knob, left/right arrow key or numeric keyboard to set the RGB luminance of the screen. The range is from 1% to 100% and the default is 50%. This setting is stored in the non-volatile memory and will not be affected by factory reset.

Display Mode

Press **Display** → **Disp Mode** to set the display mode to "Normal", "Waveform" or "Dial". The default is normal display mode. This setting is stored in the non-volatile memory and will not be affected by factory reset.

- Normal: display the voltage, current and power values of all the channels in number form.
- Waveform: display the voltage, current and power values of the channel currently selected in waveform and number forms.
- Dial: display the voltage, current and power value of the channel currently selected in dial and number forms.

Tip

When the current display mode is "Normal" or "Waveform", press  on the front panel to quickly switch between the current display mode and dial display mode.

Display Theme

Press **Display** → **Theme** and use the left/right arrow key to set the display theme to orange, green, blue or white. The default is green. This setting is stored in the non-volatile memory and will not be affected by factory reset.



User-defined Start-up Interface

DP800 allows users to define the start-up interface. First, store the content to be displayed in a USB storage device in BMP format (the picture cannot exceed 320×56 pixels). Then, read the picture file via the instrument and make the corresponding settings.

Note: DP800 only supports the flash memory USB storage device of FAT32 format.

Press **Display** → **CustomGUI** to enter the interface as shown in the figure below.



Figure 2-9 User-defined Start-up Interface

You can define the start-up interface by performing the following operations in the user-defined start-up interface.

1. Open the picture file

Press **Open File**, the instrument enters the store and recall interface and please select the desired picture file (only BMP format is supported).

2. Set the coordinate

You can set the display position of the picture selected by setting the coordinate of the upper-left corner of the picture in the interface. The picture can be displayed in Area 1 or Area 2 in Figure 2-9. Wherein, the coordinate range of Area 1 is from (0,0) to (320,55) and the coordinate range of Area 2 is from (0,145) to (320,220).

Press **Coordinate** and use the numeric keyboard and the left/right arrow key or the knob and left/right arrow key to set the coordinate. The range is related to the pixels of the picture.

3. Preview the user-defined start-up interface

Press **Preview** to preview the user-defined start-up interface. Press any key to exit the preview interface.

4. Save the settings

Press **Save** → **OK** to save the start-up interface settings.

5. Select the start-up interface

Press **Boot UI** to select the default start-up interface or the user-defined start-up interface.

Store and Recall

DP800 allows users to store various kinds of files in internal or external memory and recall the files stored when required.

DP800 provides an internal non-volatile memory (C disk) and an external memory (D disk, only available when a USB storage device is detected at the USB HOST interface on the rear panel).

Note: DP800 only supports the flash memory USB storage device of FAT32 format.

1. C Disk

Provide 10 state file storage locations (STATE 1 to STATE 10), 10 record file storage locations (REC 1 to REC 10), 10 timer file storage locations (TIMER 1 to TIMER 10) and 10 delay file storage locations (DELAY 1 and DELAY 10). Users can store the state file, record file, timer file and delay file in C disk.

2. D Disk

Only available when a USB storage device is detected at the USB HOST interface on the rear panel. Users can store state file, record file, timer file and delay file in the USB storage device and copy the files in C disk to the USB storage device. The number of files can be stored depends on the storage space of the USB storage device.

Besides, you can store the specified BMP file in a USB storage device and define the start-up interface according to the introduction in "**User-defined Start-up Interface**".

Press **Store** on the front panel to enter the interface as shown in the figure below.



Figure 2-10 Store and Recall Interface

Browser

Press **Store** → **Browser** to move the cursor to the directory or file area and then use the knob or the up/down arrow key to select the desired directory or file.

File Type

Press **Store** → **Type** to select the desired file type (including state file, record file, timer file, delay file, bitmap file and all files).

1. State File

Store the current instrument state (such as the parameter setting and system state) in "*.RSF" format in internal or external memory. At most 10 instrument states can be stored in the internal memory.

2. Record File

When the recorder is turned on, the instrument records the current output state of each channel (such as the output voltage, current and power as well as sample interval) and store them in "*.ROF" format in internal or external memory when the recorder is turned off. At most 10 record files can be stored in the internal memory.

3. Timer File

Store the edited timer parameters (the voltage, current and time values) in "*.RTF" format in internal or external memory. At most 10 timer files can be stored in the internal memory.

4. Delay File

Store the edited delay parameters (the states and time values) in "*.RDF" format in internal or external memory. At most 10 delay files can be stored in the internal memory.

5. Bitmap File

You can browse the "*.BMP" format bitmap files under the current directory. As "*.BMP" format bitmap files cannot be stored in C disk, the right side of the store and recall interface is blank when the file type is set to "*.bmp" and the current directory is C disk.

6. All File

Display all the files and folders under the directory currently selected. When this menu is selected, the save operation is not available.

Save

You can save a file following the steps below.

1. Press **Store** → **Type** to select the desired file type.
Note: The save operation is available only when the file type is "*.rsf". The timer file and the delay file can be saved separately by pressing **Timer** → **Timer Set** → **Save** and **Timer** → **Delay Set** → **Save** and the record file is saved automatically in the specified path when you turn off the recorder.
2. Press **Browser** to switch the cursor to the directory area to select the desired directory. Press **Browser** again to switch the cursor to the file area and select the desired storage directory. Press **Save** to open the filename input interface (Figure 2-11 or Figure 2-12).
3. Input the filename.
 Press **IME** to select "CH" or "EN" in the filename input interface (Figure 2-11 or Figure 2-12). Press **.** on the numeric keyboard to switch between English uppercase and lowercase.
 - English Input (include number input)
 In English input method, use the knob to select the desired character in the "Virtual Keyboard" and press **Select** to select this character; the character selected is displayed in the "Filename Input Area". Use the same method to input all the characters in the filename (you can press **.** to switch between uppercase and lowercase if needed).

The length of the filename cannot exceed 9 characters. During the input, you can press **Delete** to delete the character currently at the left of the cursor in the "Filename Input Area".

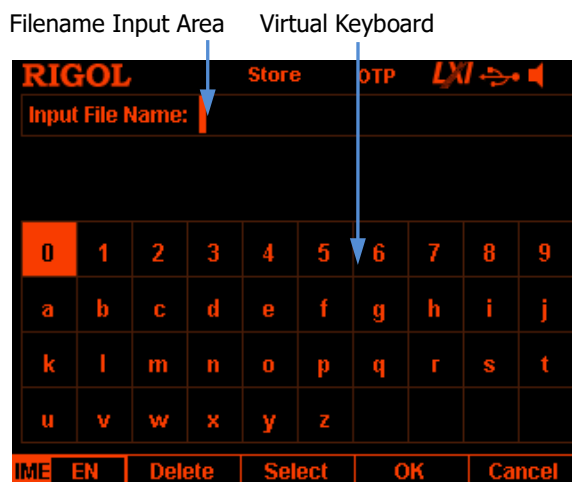



Figure 2-11 Filename Input Interface (English)

- Chinese Input
In Chinese input method, use the knob to select the desired Pinyin character in the "Virtual Keyboard" and press **Select** to select this character; the character selected is displayed in the "Pinyin Input Area" (at this point, you can press **0** on the numeric keyboard to directly input the English characters in the "Pinyin Input Area"). After inputting the pinyin of a Chinese character, select the number of the desired Chinese character using the numeric keyboard in the "Chinese Character Selection Area" (if the  or/and  icon at the right side of the "Chinese Character Selection Area" is illuminated, you can use the up/down arrow key to turn to the previous or next page) and the Chinese character selected is displayed in the "Filename Input Area". Use the same method to input all the Chinese characters in the filename.

The length of the filename cannot exceed 9 characters (a Chinese character occupies 2 characters). During the input, you can press **Delete** continuously to delete the characters in the "Pinyin Input Area" from right to left if there are characters in the "Pinyin Input Area" or you can press **Delete** to delete the Chinese character currently at the left of the cursor in the "Filename Input Area" if there is not character in the "Pinyin Input Area".

Note:

- Chinese input is not supported in uppercase state. To use the Chinese input method, press **.** to select lowercase state.
- In Chinese input method, after a number in the "Virtual Keyboard" is selected using the knob, press **Select** to select this number and the number will be directly displayed in the "Filename Input Area".

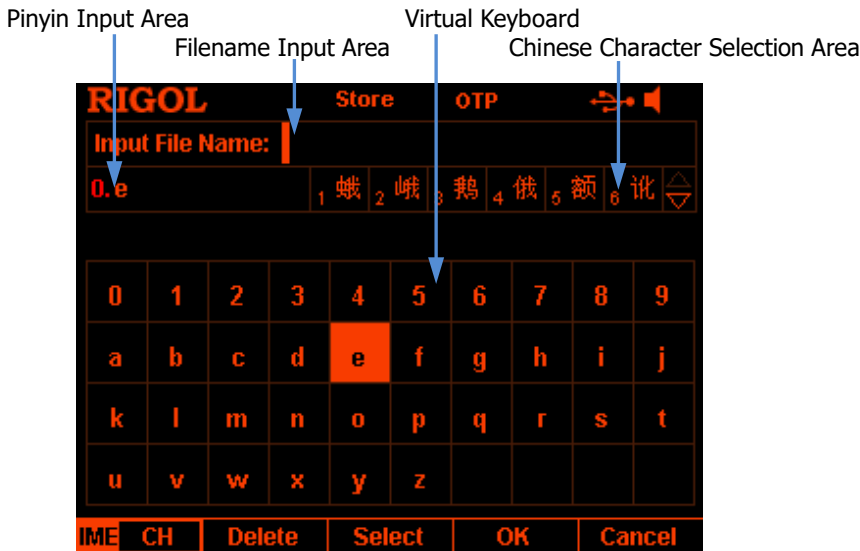

Figure 2-12 Filename Input Interface (Chinese)

4. After inputting the filename in the filename input interface, press **OK** and the instrument stores the file with the specified filename in the specified file type under the storage directory currently selected. If the storage location selected already contains a valid file, the instrument will prompt whether to overwrite the original file and press **OK** to finish the save operation.

Read

You can read the specified type of file following the steps below.

1. Press **Store** → **Type** to select the desired file type.
Note: The read operation is available only when the file type is "*.rsf" or "All File". The timer file and delay file can be read separately by pressing **Timer** → **Timer Set** → **Read** and **Timer** → **Delay Set** → **Read** and the record file can be read by pressing **...** → **Analyzer** → **Open File**.
2. Press **Browser** to switch the cursor to the directory area and select the directory of the file to be read; press **Browser** again to switch to the file area and select the file to be read.
3. Press **Read** and the instrument read the file currently selected. If the current location does not contain a valid file, the corresponding prompt message will be displayed. For a state file, the instrument enters the main interface after the file is successfully read; for other types of files, the instrument enters the corresponding function interface after the file is successfully read.

Delete

You can delete the files under C disk and D disk as well as the empty folders under D disk.

1. Press **Store** → **Browser** to move the cursor to the directory area and select the directory of the file to be deleted; press **Browser** again to switch to the file area and select the file or empty folder to be deleted.
2. Press **Delete** and the prompt message asking whether to delete the file or empty folder currently selected is displayed. Press **OK** to finish the delete operation.

Copy and Paste

You can only copy the files in C disk and paste the files to D disk.

1. Press **Store** → **Browser** to move the cursor to the directory area and select C disk; press **Browser** again to switch to the file area and select the file to be copied.
2. Press **Copy** and the instrument copies the file currently selected.
3. Press **Browser** to switch to the directory area and select D disk.
4. Press **Paste**, the instrument pastes the file copied to the D disk and the corresponding prompt message is displayed when the file is successfully pasted.

Utility

Press **Utility** on the front panel to enter the interface as shown in the figure below. This interface displays the current system parameters.



Figure 2-13 Utility Interface

1. **I/O Configuration:** set the LAN (option), RS232 (option) and GPIB (option, extended using the USB to GPIB interface converter) interface parameters.
2. **System Setting:** set the system parameters, such as the beeper and screen saver.
3. **System Information:** view system information, such as the device model and serial number.
4. **Language:** set the system language.
5. **Test/Calibration:** view the test information and calibrate the instrument manually.
6. **Print:** store the screen content into a USB storage device (FAT32 format, flash memory).
7. **Preset:** users can define the setting recalled by **Preset** on the front panel.
8. **Option:** view the current option installation information and install the option.

I/O Configuration

DP800 supports USB, LAN (option), RS232 (option) and GPIB (option, extended using the USB to GPIB interface converter) interfaces, via which you can control DP800 remotely. When the LAN, RS232 or GPIB interface is selected, please first set the interface parameters.

Press **Utility** → **I/O Config** to open the interface setting menu to set the LAN, RS232 and GPIB interface parameters.

To Set the LAN Parameters

Before using the LAN interface, use the network cable to connect the instrument to the PC or to the network of the PC.

Press **Utility** → **I/O Config** → **LAN** to open the LAN parameter setting interface as shown in the figure below. You can view the network status and configure the network parameters.

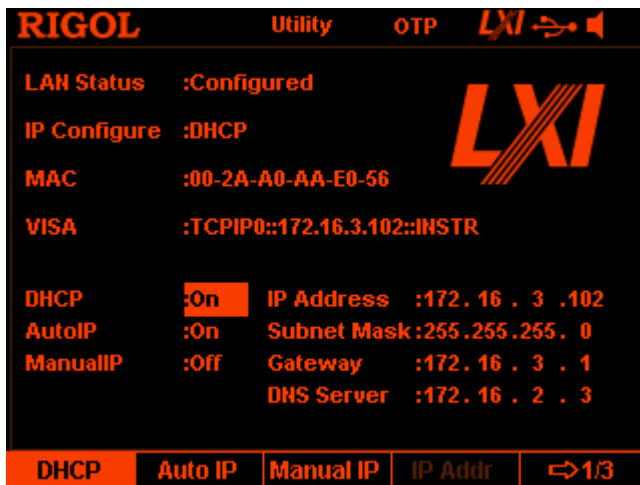

Figure 2-14 LAN Parameter Setting Interface

1. LAN Status

- Configured: the network is successfully connected.
- Disconnect: the network is not connected or the network connection fails.

2. IP Configuration Mode

There are three IP configuration modes: DHCP, Auto IP and Manual IP. If the current LAN status is "Disconnect", nothing is displayed behind "IP Configure:". In different IP configuration mode, the configuration mode of the network parameters (such as the IP address) is different.

- **DHCP:** in this mode, the DHCP server in the current network assigns network parameters (such as the IP address) for the instrument. Press **DHCP** to enable or disable the DHCP configuration mode. By default, the DHCP configuration mode is "On".
- **Auto IP:** in this mode, the instrument acquires the IP address from 169.254.0.1 to 169.254.255.254 and subnet mask 255.255.0.0 according to the current network configuration automatically. Press **Auto IP** to enable or disable the auto IP configuration mode. By default, the auto IP configuration mode is "On".

Note: When the DHCP and auto IP configuration modes are enabled at the same time, the instrument uses the DHCP configuration mode. Therefore, to use the auto IP configuration mode, **DHCP** should be set to "Off".

- **Manual IP:** in this mode, users define the network parameters (such as the IP address). Press **Manual IP** to enable or disable the manual IP configuration mode. By default, the manual IP configuration mode is "Off".

Note: When all the three configuration modes are set to "On", the priority order of parameter configuration is "DHCP", "Auto IP" and "Manual IP". Therefore, to use the manual IP configuration mode, **DHCP** and **Auto IP** should be set to "Off".

Tip

- When all the three configuration modes are set to "On", the priority order of parameter configuration is "DHCP", "Auto IP" and "Manual IP".
- The three IP configuration modes cannot all be set to "Off" at the same time.

3. MAC Address

The MAC (Media Access Control) address is also called hardware address and is used to define the location of the network device. For a power supply, the MAC address is unique and is usually used to recognize the instrument when assigning IP address for the instrument. The MAC address (48 bits, namely 6 bytes) is usually expressed in hexadecimal form, for example, 00-2A-A0-AA-E0-56.

4. VISA Descriptor

VISA (Virtual Instrument Software Architecture) is an advanced application programming interface developed by NI (National Instrument) and is used to communicate with various instrument buses. It uses the same method to communicate with the instrument regardless of the type of the instrument interface (GPIB, USB, LAN/Ethernet or RS232). The instrument communicating with it via the GPIB, USB, LAN/Ethernet or RS232 interface is called "Resource".

VISA descriptor is the resource name and describes the accurate name and location of the VISA resource. If the LAN interface is currently used to communicate with the instrument, the VISA descriptor is TCPIP::172.16.3.100::INSTR.

5. Set the IP Address

Please acquire a valid IP address from your network administrator firstly and set the IP address manually in manual IP configuration mode. The format of the IP address is nnn.nnn.nnn.nnn; wherein, the first nnn ranges from 1 to 223 (except 127) and the other three range from 0 to 255.

Press **IP Addr** and use the numeric keyboard and left/right arrow key or the knob and left/right arrow key to input the desired IP address. This setting is stored in the non-volatile memory and the instrument will load the IP address set automatically at the next power-on if **DHCP** and **Auto IP** are set to "Off".

6. Set the Subnet Mask

Please acquire a valid subnet mask from your network administrator firstly and set the subnet mask manually in manual IP configuration mode. The format of the subnet mask is nnn.nnn.nnn.nnn; wherein, the range of nnn is from 0 to 255.

Press **Sub Mask** and use the numeric keyboard and left/right arrow key or the knob and left/right arrow key to input the desired subnet mask. This setting is stored in the non-volatile memory and the instrument will load the subnet mask set automatically at the next power-on if **DHCP** and **Auto IP** are set to "Off".

7. Set the Gateway

Please acquire a valid gateway address from your network administrator firstly and set the gateway manually in manual IP configuration mode. The format of the gateway is nnn.nnn.nnn.nnn; wherein, the first nnn ranges from 1 to 223 (except 127) and the other three range from 0 to 255.

Press **Gateway** and use the numeric keyboard and left/right arrow key or the knob and left/right arrow key to input the desired gateway address. This setting is stored in the non-volatile memory and the instrument will load the gateway address set automatically at the next power-on if **DHCP** and **Auto IP** are set to "Off".

8. Set the DNS Server

Please acquire a valid DNS server address from your network administrator firstly and set the DNS (Domain Name Service) address manually in manual IP configuration mode. The format of the DNS address is nnn.nnn.nnn.nnn; wherein, the first nnn ranges from 1 to 223 (except 127) and the other three range from 0 to 255.

Press **DNS Serv** and use the numeric keyboard and left/right arrow key or the

knob and left/right arrow key to input the desired address. This setting is stored in the non-volatile memory and the instrument will load the server address set automatically at the next power-on if **DHCP** and **Auto IP** are set to "Off".

9. Default

Press **Def Cfg** and the prompt message "Restore LAN to default?" will be displayed; press **OK** to restore the network parameters to default values. At this point, the DHCP and auto IP configuration modes are enabled and the manual IP configuration mode is disabled.

10. Current Setting

Press **Cur Cfg** to view the MAC address, current network parameters and network status information of the instrument.

11. Apply the Setting

Press **Apply** to apply the network parameters currently set.

Note: After setting the network parameters, you need to press **Apply** to apply the network parameters currently set; at this point, the new settings take effect.

To Set the RS232 Parameters

Connect the RS232 interface to the PC or data terminal equipment (DTE) using RS232 cable and set the interface parameters (baud rate, parity bit, etc.) that match the PC or terminal equipment. At this point, you can control the instrument remotely.

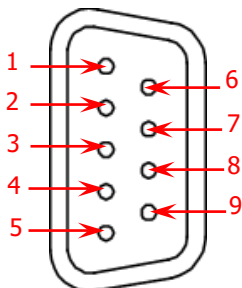

RS232 Interface

Pin	Name	Definition
1	DCD	Data Carrier Detect
2	TXD	Transmitted Data
3	RXD	Received Data
4	DTR	Data Terminal Ready
5	SGND	Signal Ground
6	DSR	Data Set Ready
7	CTS	Clear To Send
8	RTS	Request To Send
9	RI	Ring Indicator

Press **Utility** → **I/O Config** → **RS232** to open the RS232 parameter setting interface.

1. Baud Rate

Press **Baudrate** to select the desired baud rate (4800, 7200, 9600, 14400, 19200, 38400, 57600, 115200 or 128000, the unit is Baud).

2. Data Bit

Press **Data Bit** to select the desired data bit (5, 6, 7 or 8).

3. Stop Bit

Press **Stop Bit** to select the desired stop bit (1 or 2).

4. Parity Bit

Press **Parity Bit** to select the desired parity mode ("None", "Odd" or "Even").

5. Hardware Flow Control

Press **Flow Ctrl** to enable or disable the hardware flow control.

This power supply uses RTS/CTS hardware flow control mode. The instrument monitors the status of the CTS pin. When the status is "True", the instrument sends data; when the status is "False", the instrument stops sending data. The instrument sets the CTS pin to "False" when the input buffer area is almost full and sets the CTS pin to "True" when the input buffer area is available again.

To Set the GPIB Address

Before using the GPIB interface, use the USB to GPIB interface converter (option) to extend a GPIB interface and then use a GPIB cable to connect the instrument and PC.

Press **Utility** → **I/O Config** → **GPIB** and use the numeric keyboard or the left/right arrow key and knob to set the desired GPIB address. It can be any integer from 0 to 30. The default is 2. This setting is stored in the non-volatile memory and will not be affected by factory reset.

System Setting

Power-on Setting

Select the instrument configuration ("Default" or "Last") the instrument uses at power-on and the default is "Default".

- Last: use the system configuration before the last power-off.
- Default: use the factory setting (except those parameters that are not affected by factory reset). For the details, refer to
- Table 2-2.

Press **Utility** → **System** → **Power On** to select the desired configuration type. This setting is stored in the non-volatile memory and will not be affected by factory reset.

Over-temperature Protection

Press **Utility** → **System** → **OTP** to enable or disable the over-temperature protection (OTP) function. When the OTP function is enabled, the instrument turns off the output automatically when the temperature inside the instrument reaches the limit.



Beeper

Press **Utility** → **System** → **Beeper** to enable or disable the beeper. When the beeper is enabled, the instrument generates prompt sound during front panel operation or when error occurs during remote operation.

Screen Saver

Press **Utility** → **System** → **Scrn Svr** to enable or disable the screen saver function. When the screen saver function is enabled, the instrument will enter the screen saver mode automatically after standing by for 25 minutes and will enter the black screen state after another 12.5 minutes.

Keyboard Lock

DP800 allows users to lock the front panel keys to avoid the danger caused by misoperation. You can press and hold **OK** to lock the front panel keys; at this point, all the front panel keys (except the output on/off key  of each channel and the power switch key ) are not available. When the keyboard lock password is disabled, you can press and hold this key again to unlock the front panel keys. When the keyboard lock password is enabled, you need to input the correct password (2012) to unlock the front panel keys.

Press **Utility** → **System** → **Key Lock** to enable or disable the keyboard lock password.

Tip: You can also use the "**Key Locking**" function to lock or unlock the specified keys on the front panel.

Track Setting

The specified channels of DP832 and DP831 support the track function. You can select the desired tracking mode and on/off sync mode (for the details, refer to "**To Enable the Track Function**" and "**To Track the On/Off Status of the Channel Output**") according to your need.

1. Press **Utility** → **System** → **Track Set** → **Track** to select "Synchronous" or "Independent".
 - **Synchronous:** for two channels (the channels should be of the same instrument) that support the track function, the track function of the other channel will be enabled or disabled at the same time when the track function of a channel is enabled or disabled.
 - **Independent:** for two channels (the channels should be of the same instrument) that support the track function, the status of the track function of the other channel will not be affected when the track function of a channel is enabled or disabled.

2. Press **Utility** → **System** → **Track Set** → **On/Off** to select "Enable" or "Disable".
 - **Disable:** do not track the output status of the channel.
 - **Enable:** track the output status of the channel.

System Information

Press **Utility** → **Sys Info** to view the system information of the instrument, including the model, serial number, and digital board version.

System Language

DP800 supports menus in various languages and provides Chinese/English help information, prompt messages and interface display. Press **Utility** → **Language** to select the desired language.

Test/Calibration

You can view the calibration information of the instrument and calibrate the instrument.

1. Press **Utility** → **Test/Cal** to view the calibration state, calibration time and test information (include the top board, bottom board, fan, and temperature) of the instrument.
2. Press **Utility** → **Test/Cal** → **ManualCal** and input the correct password to enter the manual calibration interface. At this point, you can perform calibration on the instrument.

A default password is assigned to the instrument when it left factory. To acquire the password, please contact **RIGOL**. If you already know the password, you can modify the password (press **Utility** → **Test/Cal** → **Password** and modify the password according to the interface prompts).

Note

The recommended calibration interval is 1 year. The instrument is calibrated before leaving factory. Calibration by users themselves is not recommended and if calibration is required, please contact **RIGOL**.

Print

You can store the screen content as a picture file in the USB storage device.

Note: DP800 only supports the flash memory USB storage device of FAT32 format.

1. Insert a USB storage device into the USB HOST interface on the rear panel of the instrument. When the USB storage device is detected,  is displayed in the status bar on the screen and the corresponding prompt message is displayed.
2. Press **Utility** → **Print Set** → **Print** and the countdown label (5s) is displayed at the left of the status bar. Switch the instrument to the desired interface within 5s and the instrument stores the screen content in "*.BMP" format in the USB storage device 5s later after you press **Print**. After that, the corresponding prompt message is displayed.

When no USB storage device is currently detected, press **Print** and the prompt message "USB storage device does not exist." will be displayed.

Preset Setting

Press **Utility** → **Preset** to define the setting recalled by **Preset** on the front panel. Pressing **Preset** can restore the instrument to factory setting or recall the user-defined settings.

To Restore to Factory Setting

Press **Utility** → **Preset** to enter the interface as shown in the figure below. Press **Preset Key** to select "Default" or any of the 4 groups of user-defined settings and by default, "Default" is selected. When "Default" is selected, pressing **Preset** on the front panel will restore the instrument to factory setting as shown in Table 2-2 on the next page.

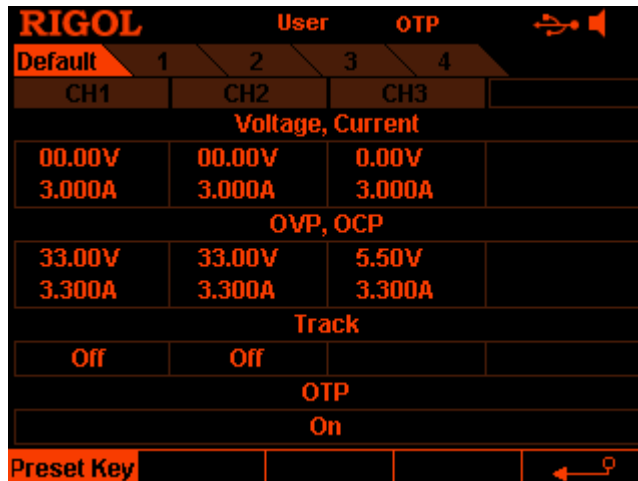

Figure 2-15 Preset Value Type Selecting Interface

Table 2-2 Factory setting

Channel Parameters	
DP832	
Voltage/Current Setting Values	CH1: 00.00V/3.000A CH2: 00.00V/3.000A CH3: 0.00V/3.000A
Voltage/Current Limits	CH1: 33.00V/3.300A CH2: 33.00V/3.300A CH3: 5.50V/3.300A
OVP/OCP On/Off	CH1/CH2/CH3: Off/Off
Output On/Off	CH1/CH2/CH3: Off
Track On/Off	CH1/CH2: Off CH3: None
Current Channel	CH1
DP831	
Voltage/Current Setting Values	CH1: 0.000V/5.000A CH2: 00.00V/2.000A CH3: -00.00V/2.000A
Voltage/Current Limits	CH1: 8.800V/5.500A CH2: 33.00V/2.200A CH3: -33.00V/2.200A
OVP/OCP On/Off	CH1/CH2/CH3: Off/Off
Output On/Off	CH1/CH2/CH3: Off
Track On/Off	CH1: None CH2/CH3: Off
Current Channel	CH1
DP822	
Voltage/Current Setting Values	CH1: 00.00V/5.000A CH2: 0.00V/16.00A
Voltage/Current Limits	CH1: 22.00V/5.500A CH2: 5.50V/16.80A
OVP/OCP On/Off	CH1/CH2: Off/Off
Output On/Off	CH1/CH2: Off
Sense Function On/Off	CH1: None CH2: Off
Current Channel	CH1
DP821	
Voltage/Current Setting Values	CH1: 00.00V/1.000A CH2: 0.00V/10.00A
Voltage/Current Limits	CH1: 66.00V/1.100A CH2: 8.80V/11.00A
OVP/OCP On/Off	CH1/CH2: Off/Off
Output On/Off	CH1/CH2: Off
Sense Function On/Off	CH1: None CH2: Off
Current Channel	CH1

DP813	
Voltage/Current Setting Values	00.00V/20.00A
Voltage/Current Limits	8.80V/22.00A
OVP/OCF On/Off	Off/Off
Output On/Off	Off
Sense Function On/Off	Off
Current Range	Range1
DP811	
Voltage/Current Setting Values	00.00V/05.00A
Voltage/Current Limits	22.00V/11.00A
OVP/OCF On/Off	Off/Off
Output On/Off	Off
Sense Function On/Off	Off
Current Range	Range1

Display	
Brightness*	50%
Contrast*	25%
RGB Luminance*	50%
Display Mode*	Normal
Theme*	Green

System Setting	
Language*	Chinese(s)
Power-on Setting*	Default
OTP	On
Beeper	On
Screen Saver	Off
Keyboard Lock*	Off
Track Mode	Synchronous
On/Off Sync	Disable
Preset	Default
Print Destination	USB Disk
Print Copies	1
Print Format	BMP
Print Invert	Yes
Print Color	GrayScale

I/O Configuration*	
GPIB Address	2
RS232	
Baud Rate	9600
Data Bit	8
Stop Bit	1
Parity Bit	None
Hardware Flow Control	Off

LAN	
DHCP	On
Auto IP	On
Manual IP	Off

Timer	
Channel	CH1
Timer On/Off	Off
Output Groups	1
Timer Parameters	Volt: 1V; Curr: 1A; Time: 1s
Cycles	1
End State	Outp Off
Templet	Sine

Sine	
Object	Voltage
Current	0A
Maximum	1V
Minimum	0V
Total Number of Points	10
Interval	1s
Invert	Off

Delayer	
Channel	CH1
Delayer On/off	Off
Output Groups	1
Delay Parameter	State: Off, On alternately
Cycles	1
End State	Outp Off
State Generation	0 1Patt
Time Generation	FixTime
Fixed Time	On Delay: 1s; Off Delay: 1s
Increase/Decline	Time Base: 1s; Step: 1s
Stop Condition	None

Recorder	
Recorder Switch	Off
Record Period	1s
Destination	C:\REC 10;RIGOL.ROF

Analyzer	
Channel	CH1
Analysis Object	Voltage
Display	Curve
Current Time	1s
Start Time	1s
End Time	2s
Number of Groups	0
Median	0V
Mode	0V
Average	0V
Variance	0V
Range	0V

Maximum	0V
Minimum	0V
Mean Deviation	0V

Monitor	
Channel	CH1
Monitor Switch	Off
Monitor Condition	>Volt
Voltage	Half of the rated value of CH1 (for DP813/DP811, it is half of the rated value of Range1)
Current	Half of the rated value of CH1 (for DP813/DP811, it is half of the rated value of Range1)
Power	The product of the two values above
Stop Mode	Output Off, Warning, Beeper

Trigger	
Trig	In
Trigger Input	
Data Line	D0
Source under Control	CH1
Trigger Type	Rise Edge
Output Response	Output Off
Sensitivity	Low
Enable	No
Trigger Output	
Data Line	D0
Control Source	CH1
Trigger Condition	Output Off
Output Signal	Level
Square	Period: 1s; Duty Cycle: 50%
Polarity	Positive
Enable	No

Store	
Browser	Directory
Directory	C:\
File	The first file
File Type	*.rsf

Note*: These parameters are not affected by factory reset (when "Default" is selected in **Utility** → **System** → **Power On**, restarting the power supply will restore it to the factory setting).

To Recall the User-defined Setting

In the interface as shown in Figure 2-15, press **Preset Key** to select the specified user-defined setting (take user-defined setting 1 as an example) to enter the user-defined setting interface (the current user-defined setting is displayed in the interface) as shown in Figure 2-16. At this point, pressing **Preset** on the front panel will recall the corresponding user-defined setting.

RIGOL		User	OTP	
Default	1	2	3	4
CH1	CH2	CH3		User 1
Voltage, Current				
03.30V 1.000A	03.30V 1.000A	1.50V 1.000A		
OVP, OCP				
33.00V 3.300A	33.00V 3.300A	5.50V 3.300A		
Track				
Off	Off			
OTP				
On				
Preset Key	Voltage	Current	OVP Off	↔1/3

Figure 2-16 User-defined Setting Interface

You can set the user-defined setting currently selected according to the steps below in the interface as shown in Figure 2-16.

1. Use the left/right arrow key and knob to edit the name of the current user-defined setting (the default names of the 4 user-defined settings are user1, user2, user3 and user4 respectively).
2. Press the channel selection keys on the front panel to select the desired channel (the channel currently selected is highlighted).
3. Press **Voltage (Current)** and use the numeric keyboard or the left/right arrow key and knob to set the voltage (current) of the channel currently selected.
4. Press **OVP (OCP)** and use the numeric keyboard or the left/right arrow key and knob to set the OVP (OCP) value of the channel currently selected. Press **OVP (OCP)** repeatedly to enable or disable the OVP (OCP) function of the channel currently selected.
5. Press **Track** repeatedly to enable or disable the track function of the channel currently selected.
6. Press **OTP** repeatedly to enable or disable the over-temperature function of the

instrument.

7. Press **OK** to save the current user-defined setting.

You can also press **Default** to restore the parameters of the user-defined setting to the default.

Options

Press **Utility** → **Option** to enter the option interface and you can view the current option installation information. To install the desired option, please order the corresponding option according to the order number provided in "**Appendix A: Accessories and Options**" in this manual.

To install an option, the option license is required (each instrument corresponds to a license). The option license is a 28-character string consisting of uppercase English letters and numbers. When the desired option is purchased, you can obtain the corresponding key (the key is used to acquire the option license). You can install the option following the steps below.

1. Acquire the option license

- 1) Log in the **RIGOL** official website (www.rigol.com). Click **License Activation** to enter the "Registered product license code" interface.
- 2) In the software license registration interface, input the correct key, serial number (press **Utility** → **Sys Info** to acquire the serial number of the instrument) and the verification code. click **Generate** to obtain the download link of the option license file. If you need to use the option license file, please click the link to download the file to the root directory of the USB storage device.

2. Install the option

DP800 series power supply supports the following three option installation modes.

1) Front panel operation

- Press **Utility** → **Option** → **Install** to enter the filename input interface and the input method is fixed at "EN".
- Input the correct option license and click **OK** (for the inputting method, refer to "**Save**").

Note: The hyphens are not included in the option license.

2) Read the option installation file in the USB storage device

The content and format requirements of the option installation file are as follows.

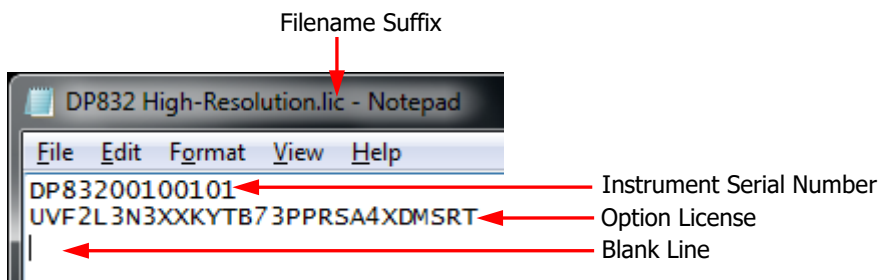

- The filename suffix must be ".lic".
- The file content requirements:
 - The first line: instrument serial number (press **Utility** → **Sys Info** to acquire the serial number of the instrument);
 - The second line: the option license;
 - The third line: a blank line (cannot be omitted).**Note:** The hyphens are not included in the option license.

The option installation procedures:

- Edit the option installation file according to the above requirements and store it into a USB storage device.
- Turn on the instrument and insert the USB storage device. Press **Store** to enter the store and recall interface.
- Read the option installation file following the steps below in the store and recall interface (refer to "**Store and Recall**").
 - Select "D:" → set the file type to "All File" → select the installation file mentioned above → press **Read**.

3) Send SCPI command

Open the remote control window and send the option installation command (:LIC:SET <license>) by referring to "**Remote Control**".

Wherein, <license> is the option license (note that the hyphens should be omitted).

For example, :LIC:SET UVF2L3N3XXKYTB73PPRSA4XDMSRT.

If the option is successfully installed, the prompt message informing you that the option installation succeeds will be displayed; otherwise, the corresponding error message will be displayed.

Key Locking

To avoid the adverse effect caused by misoperation, you can lock the specified key or all the keys (except the power switch key) on the front panel using SCPI command.

1. Key locking command introduction

```
:SYSTem:KLOCK <key>,{ON|OFF|0|1}          /*Lock or unlock the specified
                                          key*/
:SYSTem:KLOCK? <key>                       /*Query whether the specified
                                          key is locked*/
```

Wherein, <key> is used to specify the key and the range is as follows.

DISPLAY STORAGE UTILITY HELP TIMER ADVANCE PRESET	/*Function keys*/
CH1 CH2 CH3	/*Channel selection keys*/
RANGE1 RANGE2 [¹]	/*Range selection keys*/
M1 M2 M3 M4 M5	/*Menu keys*/
NUM0 NUM1 NUM2 NUM3 NUM4 NUM5 NUM6 NUM7 NUM8 NUM9 DOT	/*Numeric keys*/
LEFT RIGHT UP DOWN	/*Arrow keys*/
OUTPUT1 OUTPUT2 OUTPUT3 OUTPUTALL	/*Output on/off keys*/
KNOB OK BACK DIAL	/*Knob, OK, Back and dial keys*/
ALL	/*All the keys (except the power switch key) and knob on the front panel*/

Note^[1]: The parameters are for the single-channel model.

{ON|OFF|0|1} is used to lock or unlock the keys. Selecting ON|1 denotes locking the specified key; selecting OFF|0 denotes unlocking the specified key.

2. The three methods to lock or unlock the keys

(1) Edit a command file that meets the following requirements and store it to a USB storage device; read this file via the instrument to lock or unlock the specified key

The content and format requirements of the command file are as follows.

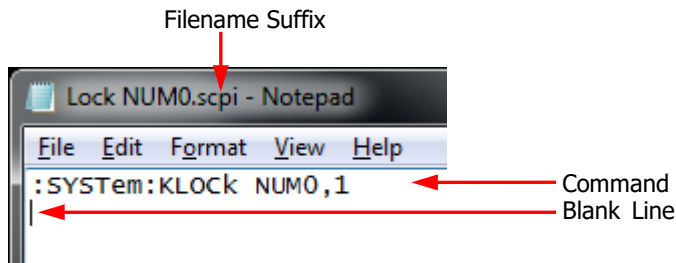

- The filename suffix must be ".scpi".
- The length of the filename cannot exceed 20 characters.
- The file content requirements:
 - The first line: the command used to lock or unlock the specified key.
 - The second line: a blank line (cannot be omitted).

Note: The command file can contain multiple lines (for example, N lines). The first N-1 lines are the commands used to lock or unlock the specified keys and the Nth line is blank. At this point, you can execute N-1 locking or unlocking operations by reading the file via the instrument.

Operation Procedures:

- Edit a command file that meets the above requirements and store it to a USB storage device.
- Start the instrument and insert the USB storage device. Press **Store** to enter the store and recall interface.
- In the store and recall interface, read the command file following the steps below by referring to the introductions in "**Store and Recall**". Select "D:" → set the file type to "All File" → select the file mentioned above → press **Read**.

(2) Send command via Ultra Sigma to lock or unlock the specified key

- Build the communication between the instrument and PC.
- Run Ultra Sigma and search for instrument resource.
- Open the remote command control panel and send the command.

(3) Program and send command to lock or unlock the specified key

- Build the communication between the instrument and PC.
- Use a programming language (such as LabVIEW and C#) to program and send command.

Tip: You can also use the "**Keyboard Lock**" function to lock or unlock the front panel keys.

Chapter 3 Remote Control

DP800 series power supply can be controlled remotely via the following two modes.

User-defined programming

Users can program and control the instrument by using the SCPI (Standard Commands for Programmable Instruments) commands. For more information about the commands and programming, refer to the *DP800 Programming Guide*.

Use PC software

Users can use the PC software to send commands to control the instrument remotely. Ultra Sigma of **RIGOL** is recommended. You can download Ultra Sigma from **RIGOL** official website (www.rigol.com).

This power supply can communicate with PC through USB, LAN, RS232 and GPIB (with the USB to GPIB interface converter provided by **RIGOL**) instrument buses. This chapter will give a detailed introduction of how to use **Ultra Sigma** to control the power supply remotely through various interfaces.

The contents of this chapter are as follows:

- Remote Control via USB
- Remote Control via LAN (option)
- Remote Control via GPIB (option)
- Remote Control via RS232 (option)

Remote Control via USB

1. Connect the device

Connect the USB DEVICE interface on the rear panel of the power supply with your PC using a USB cable.

2. Install the USB driver

This power supply is a USB-TMC device. After you connect the power supply to the PC and turn both on for the first time (the power supply is automatically configured to USB interface), the Found New Hardware Wizard as shown in the figure below is displayed on the PC. Please install the "USB Test and Measurement Device (IVI)" driver following the directions in the wizard. The steps are as follows.

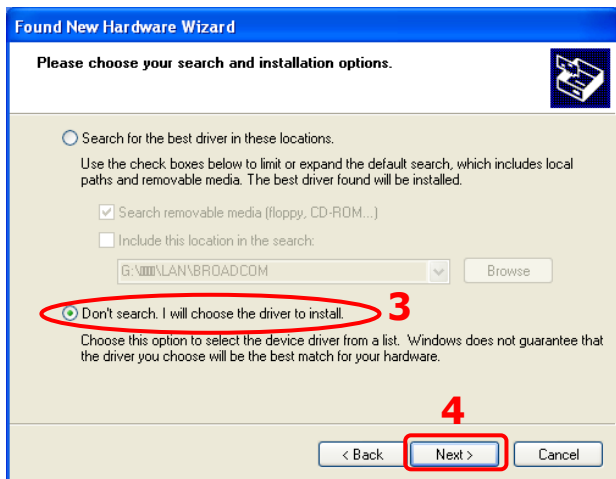
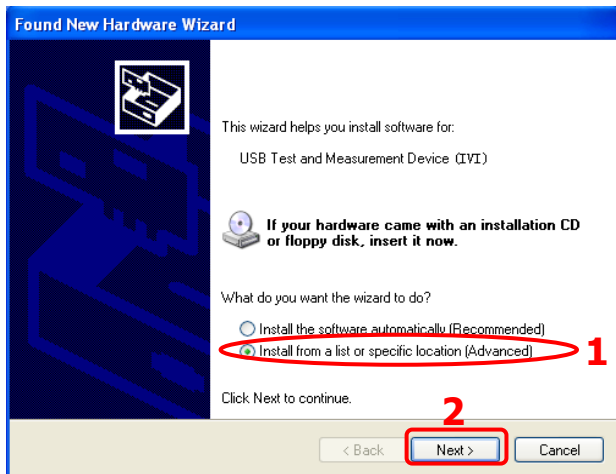

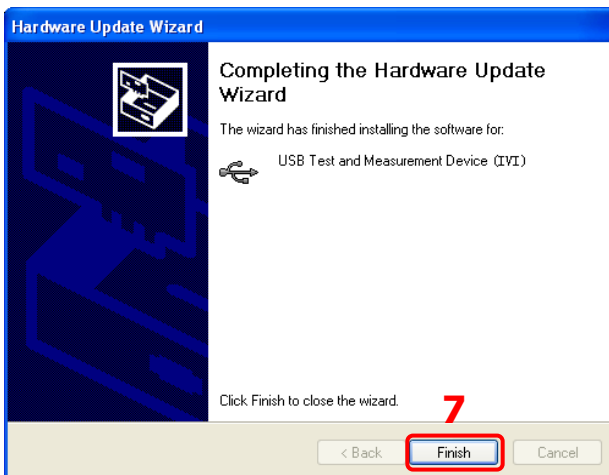
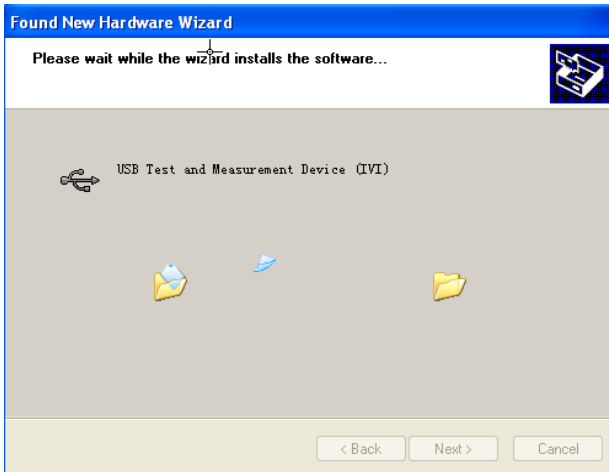
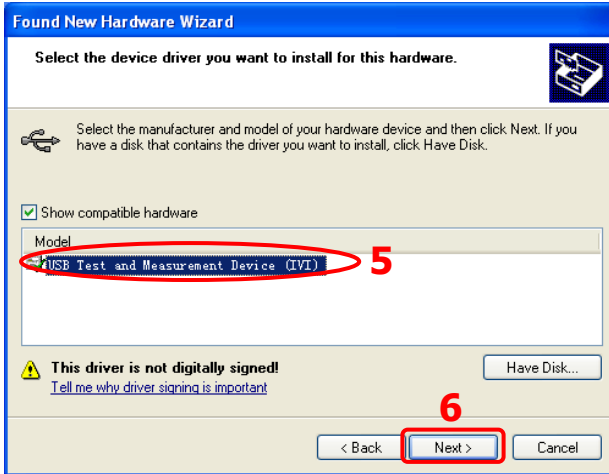

3. Search for device resource

Start up **Ultra Sigma** and the software will automatically search for the instrument resource currently connected to the PC via the USB interface. You can also click **USB-TMC** to search for the resource.

4. View the device resource

The resource found will appear under the "RIGOL Online Resource" directory and the model number and USB interface information of the instrument will also be displayed as shown in the figure below.

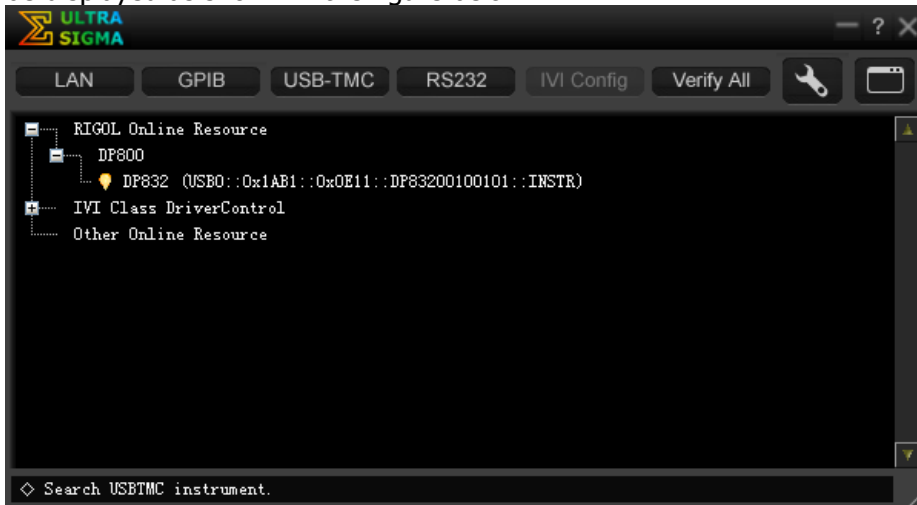

5. Control the instrument remotely

Right click the resource name "DP832 (USB0::0x1AB1::0x0E11::DP83200100101::INSTR)" and select "SCPI Panel Control" to turn on the remote command control panel through which you can send commands and read data.

Remote Control via LAN (option)

1. Connect the device

Connect the power supply to your PC or the LAN of your PC using a network cable.

2. Configure network parameters

1) DHCP mode:

If the network supports DHCP, the DHCP server in the network assigns network parameters (IP Address, Subnet Mask, Gateway and DNS) for the power supply automatically.

2) Auto IP mode:

When the network doesn't support DHCP, the DHCP mode of the power supply is disabled or the power supply is connected to the PC directly, the power supply selects Auto IP mode and acquires the IP address from 169.254.0.1 to 169.254.255.254 and subnet mask 255.255.0.0 automatically.

3) Manual IP mode:

Enable the Manual IP mode and disable the DHCP mode as well as the Auto IP mode to set the network parameters manually.

If the power supply is connected to the PC directly, set the IP Addresses, Subnet Masks and Gateways for both of the PC and the power supply. The Subnet Masks and Gateways of the power supply and PC must be the same and the IP Addresses of them must be within the same network segment (for details, refer to the TCP/IP protocol). An example is shown in the table below.

Network Parameters	PC	Power Supply
IP Address	192.16.3.3	192.16.3.8
Subnet Mask	255.255.255.0	255.255.255.0
Default Gateway	192.16.3.1	192.16.3.1

If your power supply is connected to the LAN of your PC, please acquire a set of valid network parameters (IP Address, Subnet Mask, Gateway and DNS) from your network administrator and configure the network parameters of the power supply according to the description in "**To Set the LAN Parameters**".

3. Search for device resource

Start up **Ultra Sigma** and click **LAN**. The window as shown in figure (a) is displayed. Click **Search** and the software will search for the instrument resource currently connected to the PC or the local area network of the PC via the network cable. The resource name of the instrument found is displayed at the right of the window as shown in figure (b). Click **OK** to add the resource.

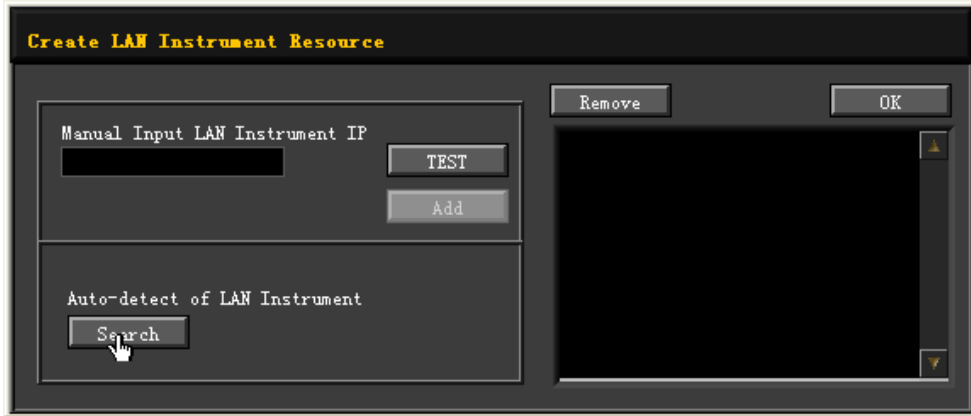

(a)

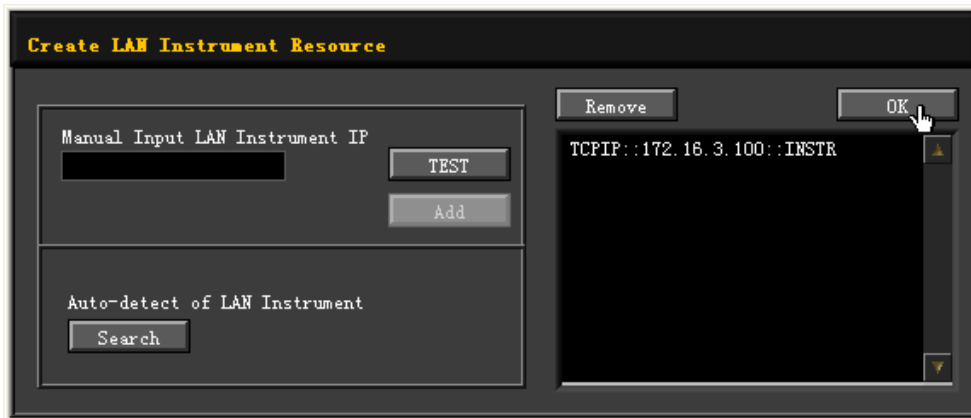

(b)

Note: If you want to remove the unwanted resource, click the corresponding resource name to select it and then click **Remove**.

4. View the device resource

The resource found will appear under the "RIGOL Online Resource" directory as shown in the figure below.



5. Control the instrument remotely

Right click the resource name "DP832 (TCPIP::172.16.3.100::INSTR)" and select "SCPI Panel Control" to turn on the remote command control panel through which you can send commands and read data.

6. Load LXI webpage

As this power supply conforms to LXI Core 2011 Device standard, you can load LXI webpage through **Ultra Sigma** (right click the resource name and select "LXI-Web") or directly input the IP address of the instrument in the address bar of the PC browser. Various important information about the instrument (including the model, manufacturer, serial number, description, MAC address and IP address) will be displayed on the webpage.

Remote Control via GPIB (option)

1. Connect the device

Use the USB to GPIB interface converter to extend a GPIB interface for the power supply. Then, connect the power supply to your PC using a GPIB cable.

2. Install the driver of GPIB card

Install the driver of the GPIB card which has been connected to the PC correctly.

3. Set the GPIB address

Set the GPIB address of the power supply according to the description in "**To Set the GPIB Address**".

4. Search device resource

Start up **Ultra Sigma** and click **GPIB** to open the window as shown in figure (a). Click **Search** and the software will search for the instrument resource currently connected to the PC via the GPIB interface. The resource name of the instrument found will be displayed on the right side of the window as shown in figure (b). Click **OK** to add the instrument resource.



(a)



(b)

Note: If you want to remove the unwanted resource, click the corresponding

resource name to select it and then click **Remove**.

If resource cannot be found automatically:

- Select the GPIB card address of the PC from the dropdown box of "GPIB0::" and select the GPIB address set in the power supply from the dropdown box of "0::INSTR".
- Click **TEST** to check whether the GPIB communication works normally; if not, please follow the corresponding prompt messages to solve the problem.

5. View the device resource

The resource found will appear under the "RIGOL Online Resource" directory as shown in the figure below.



6. Control the instrument remotely

Right-click the resource name "DP832 (GPIB0::18::INSTR)" and select "SCPI Panel Control" to turn on the remote command control panel through which you can send commands and read data.

Remote Control via RS232 (option)

1. Connect the device

Connect the power supply to your LAN using a RS232 cable.

2. Set the RS232 parameters

Press **Utility** → **I/O** → **RS232** to set the parameters relating to RS232 according to the introduction in "**To Set the RS232 Parameters**".

3. Add device resource

Start up **Ultra Sigma** and click **RS232** to open the window as shown in figure (a). Select the device resource name to be added and set the corresponding parameters (such as the baud rate and parity bit) according to the current RS232 parameter setting of the instrument (Note: `\r\n` must be selected as the End Mark). After that, click **TEST** and the dialog box as shown in figure (b) is displayed. Click **OK**; at this point, **Add** is available; click **Add** and the device resource name currently selected will be displayed at the right of the window (as shown in figure (c)). Click **OK** to add the instrument resource.

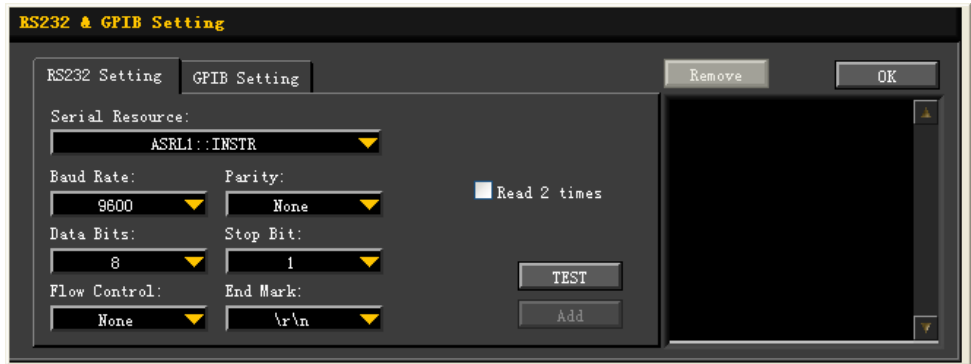

(a)

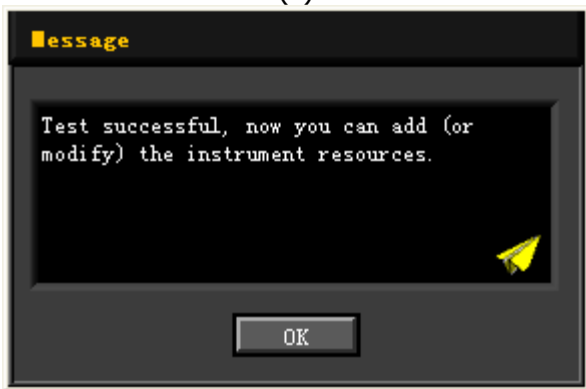

(b)

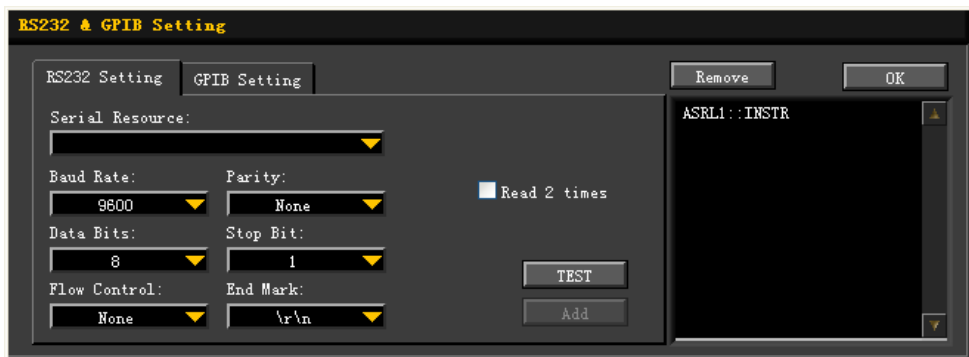

(c)

Note: If the test fails, please check whether the instrument can communicate normally with the PC via the RS232 cable and whether the RS232 parameters of the software match with the current settings of the instrument.

4. View the device resource

The RS232 device resource name added will appear under the "RIGOL Online Resource" directory as shown in the figure below.

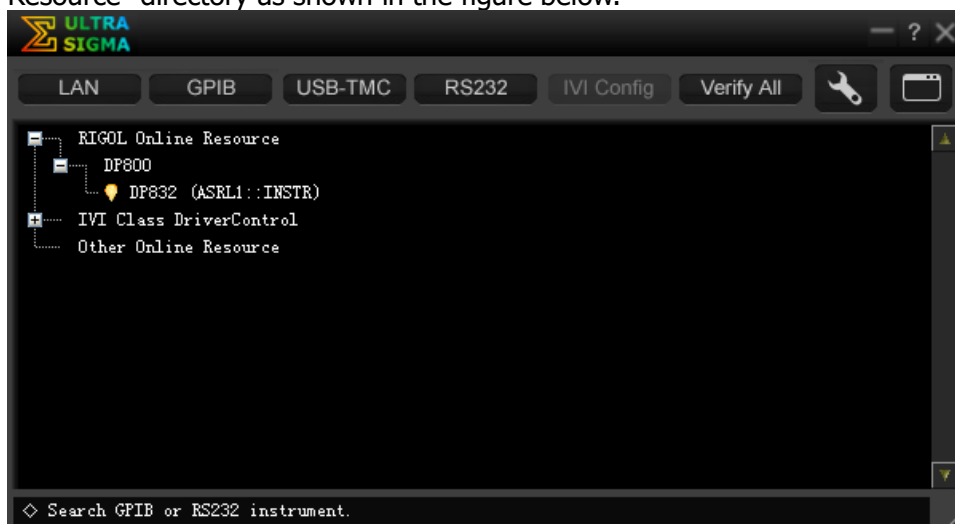

5. Control the instrument remotely

Right click the resource name "DP832 (ASRL1::INSTR)" and select "SCPI Panel Control" to turn on the remote command control panel through which you can send commands and read data.

Chapter 4 Troubleshooting

The following failures might occur when using this instrument. Please solve the problem according to the following method; if the problem remains, please contact **RIGOL** and provide the device information of your instrument (**Utility** → **Sys Info**).

1. The instrument does not start.

- (1) Check the power cord connection.
- (2) Check whether the power switch on the front panel is turned on.
- (3) Remove the power cord and check whether the voltage selector is at the proper scale and whether the fuse specification is correct and the fuse is in good condition. To replace the fuse, refer to "**To Replace the Fuse**".
- (4) If the problem persists, please contact **RIGOL**.

2. The constant voltage output is abnormal.

- (1) Check whether the maximum output power of the scale selected fulfills the load requirement. If yes, turn to the next step.
- (2) Check whether the cable connecting the load and power supply is short-circuited and whether it is in good contact.
- (3) Check whether the load works normally.
- (4) Check whether the current setting value of this scale is proper; if it is too low, increase the current setting value properly.
- (5) If the problem persists, please contact **RIGOL**.

3. The constant current output is abnormal.

- (1) Check whether the maximum output power of the scale selected meets the requirement of the load. If yes, turn to the next step.
- (2) Check whether the cable connecting the load and power supply is short-circuited and whether it is in good contact.
- (3) Check whether the load works normally.
- (4) Check whether the voltage setting value of this scale is proper; if it is too low, increase the voltage setting value properly.
- (5) If the problem persists, please contact **RIGOL**.

4. The USB storage device cannot be recognized.

- (1) Check whether the USB storage device can work normally.
- (2) Make sure that a flash memory USB storage device of FAT32 format is used, as this instrument does not support hard disk USB storage device.
- (3) Restart the instrument and insert the USB storage device to check it.
- (4) If the USB storage device still cannot work normally, please contact **RIGOL**.

Chapter 5 Specifications

All the specifications are guaranteed when the instrument has been working for more than 30 minutes under the specified operation temperature.

Note: Unless otherwise noted, the specifications are applicable to all the channels of the specified model.

DC Output (0°C to 40°C)			
Channel (Range)		Voltage/Current	OVP/OCP
DP832	CH1	0 to 30V/0 to 3A	10mV to 33V/1mA to 3.3A
	CH2	0 to 30V/0 to 3A	10mV to 33V/1mA to 3.3A
	CH3	0 to 5V/0 to 3A	10mV to 5.5V/1mA to 3.3A
DP831	CH1	0 to 8V/0 to 5A	10mV to 8.8V/1mA to 5.5A
	CH2	0 to 30V/0 to 2A	10mV to 33V/1mA to 2.2A
	CH3	0 to -30V/0 to 2A	-10mV to -33V/1mA to 2.2A
DP822	CH1	0 to 20V/0 to 5A	10mV to 22V/1mA to 5.5A
	CH2	0 to 5V/0 to 16A	10mV to 5.5V/1mA to 16.8A
DP821	CH1	0 to 60V/0 to 1A	10mV to 66V/10mA to 1.1A
	CH2	0 to 8V/0 to 10A	10mV to 8.8V/10mA to 11A
DP813	Range1	0 to 8V/0 to 20A	10mV to 8.8V/10mA to 22A
	Range2	0 to 20V/0 to 10A	10mV to 22V/10mA to 11A
DP811	Range1	0 to 20V/0 to 10A	10mV to 22V/10mA to 11A
	Range2	0 to 40V/0 to 5A	10mV to 44V/10mA to 5.5A

Load Regulation Rate \pm (Output Percentage+Offset)	
Voltage	<0.01%+2mV
Current	<0.01%+250 μ A

Linear Regulation Rate \pm (Output Percentage+Offset)	
Voltage	<0.01%+2mV
Current	<0.01%+250 μ A

Ripples and Noise (20Hz to 20MHz)	
Normal Mode Voltage	DP831/DP832/DP822/DP821: <350 μ Vrms/2mVpp DP813/DP811: <350 μ Vrms/3mVpp
Normal Mode Current	<2mArms

Annual Accuracy ^[1] (25°C \pm 5°C) \pm (Output Percentage+Offset)				
Channel	Programming		Readback	
	Voltage	Current	Voltage	Current

DP832	CH1	0.05%+20mV	0.2%+5mA	0.05%+10mV	0.15%+5mA
	CH2	0.05%+20mV	0.2%+5mA	0.05%+10mV	0.15%+5mA
	CH3	0.1%+5mV	0.2%+5mA	0.1%+5mV	0.15%+5mA
DP831	CH1	0.1%+5mV	0.2%+10mA	0.1%+5mV	0.2%+10mA
	CH2	0.05%+20mV	0.2%+5mA	0.05%+10mV	0.1%+5mA
	CH3	0.05%+20mV	0.2%+5mA	0.05%+10mV	0.1%+5mA
DP822	CH1	0.1%+25mV	0.2%+10mA	0.1%+25mV	0.15%+10mA
	CH2	0.05%+10mV	0.2%+10mA	0.05%+5mV	0.15%+10mA
DP821	CH1	0.1%+25mV	0.2%+10mA	0.1%+25mV	0.15%+10mA
	CH2	0.05%+10mV	0.2%+10mA	0.05%+5mV	0.15%+10mA
DP813	CH1	0.05%+10mV	0.1%+10mA	0.05%+10mV	0.1%+10mA
DP811	CH1	0.05%+10mV	0.1%+10mA	0.05%+10mV	0.1%+10mA

Resolution							
Channel		Programming		Readback		Display	
		Voltage	Current	Voltage	Current	Voltage	Current
DP832	CH1 CH2 CH3	Standard					
		10mV	1mA	10mV	1mA	10mV	10mA
		10mV	1mA	10mV	1mA	10mV	10mA
		10mV	1mA	10mV	1mA	10mV	10mA
		With the high-resolution option					
		1mV	1mA	0.1mV	0.1mA	1mV	1mA
		1mV	1mA	0.1mV	0.1mA	1mV	1mA
		1mV	1mA	0.1mV	0.1mA	1mV	1mA
DP831	CH1 CH2 CH3	Standard					
		1mV	1mA	1mV	1mA	10mV	10mA
		10mV	1mA	1mV	1mA	10mV	10mA
		10mV	1mA	1mV	1mA	10mV	10mA
		With the high-resolution option					
		1mV	0.3mA	0.1mV	0.1mA	1mV	1mA
		1mV	0.1mA	0.1mV	0.1mA	1mV	1mA
		1mV	0.1mA	0.1mV	0.1mA	1mV	1mA
DP822	CH1 CH2	Standard					
		10mV	10mA	10mV	1mA	10mV	10mA
		10mV	10mA	10mV	10mA	10mV	10mA
		With the high-resolution option					
		1mV	1mA	1mV	0.1mA	1mV	0.1mA
				1mV	1mA	1mV	1mA
DP821	CH1 CH2	Standard					
		10mV	1mA	10mV	1mA	10mV	1mA
		10mV	10mA	10mV	10mA	10mV	10mA
		With the high-resolution option					

		1mV 1mV	0.1mA 1mA	1mV 1mV	0.1mA 1mA	1mV 1mV	0.1mA 1mA
DP813	CH1	Standard					
		10mV	10mA	10mV	10mA	10mV	10mA
		With the high-resolution option					
		1mV	1mA	1mV	1mA	1mV	1mA
DP811	CH1	Standard					
		10mV	10mA	1mV	1mA	10mV	10mA
		With the high-resolution option					
		1mV	0.5mA	0.1mV	0.1mA	1mV	1mA

Transient Response Time

Less than 50 μ s for output voltage to recover to within 15mV following a change in output current from full load to half load or vice versa.

Command Processing Time [2]

<118ms

OVP/OC

Accuracy \pm (Output Percentage+Offset) 0.5%+0.5V/0.5%+0.5A

Voltage Programming Control Speed (1% within the total variation range)

Channel		Rise		Fall	
		Full Load	No Load	Full Load	No Load
DP832	CH1	<50ms	<33ms	<46ms	<400ms
	CH2	<50ms	<38ms	<46ms	<400ms
	CH3	<15ms	<14ms	<24ms	<100ms
DP831	CH1	<18ms	<17ms	<20ms	<200ms
	CH2	<33ms	<36ms	<44ms	<400ms
	CH3	<35ms	<42ms	<45ms	<400ms
DP822	CH1	<30ms	<30ms	<30ms	<1000ms
	CH2	<15ms	<15ms	<15ms	<250ms
DP821	CH1	<110ms	<30ms	<110ms	<800ms
	CH2	<15ms	<15ms	<20ms	<400ms
DP813	CH1	<30ms	<30ms	<20ms	<1500ms
DP811	CH1	<45ms	<42ms	<51ms	<1089ms

Temperature Coefficient per °C (Output Percentage+Offset)

Channel		Voltage	Current
DP832	CH1	0.01%+5mV	0.01%+2mA
	CH2	0.01%+5mV	0.01%+2mA
	CH3	0.01%+2mV	0.01%+2mA

DP831	CH1	0.01%+2mV	0.02%+3mA
	CH2	0.01%+2mV	0.02%+3mA
	CH3	0.01%+2mV	0.02%+3mA
DP822	CH1	0.02%+1mV	0.1%+1mA
	CH2	0.02%+1mV	0.1%+1mA
DP821	CH1	0.01%+3mV	0.02%+3mA
	CH2	0.01%+3mV	0.02%+3mA
DP813	CH1	0.02%+1mV	0.1%+2mA
DP811	CH1	0.01%+3mV	0.02%+3mA

Stability ^[3] ±(Output Percentage+Offset)

Channel		Voltage	Current
DP832	CH1	0.02%+2mV	0.05%+2mA
	CH2	0.02%+2mV	0.05%+2mA
	CH3	0.01%+1mV	0.05%+2mA
DP831	CH1	0.03%+1mV	0.1%+3mA
	CH2	0.02%+2mV	0.05%+1mA
	CH3	0.02%+2mV	0.05%+1mA
DP822	CH1	0.02%+1mV	0.1%+1mA
	CH2	0.02%+1mV	0.1%+1mA
DP821	CH1	0.02%+1mV	0.1%+1mA
	CH2	0.02%+1mV	0.1%+1mA
DP813	CH1	0.02%+1mV	0.1%+2mA
DP811	CH1	0.02%+1mV	0.1%+1mA

Mechanical

Dimensions	239mm(W) x 157mm(H) x 418mm(D)
Weight	DP832: 10.5kg DP831: 9.75kg DP822: 10.5kg DP821: 10.0kg DP813: 10.5kg DP811: 10.3kg

Power

AC Input (50Hz-60Hz)	100Vac±10%, 115Vac±10%, 230Vac±10% (maximum 250Vac)
Maximum Power	DP832: 521VA DP831: 416VA DP822: 500VA DP821: 450VA DP813: 503VA DP811: 503VA

I/O	
USB Device	1
USB Host	1
LAN	1 (optional)
RS232	1 (optional)
Digital IO	1 (optional)
USB-GPIB	1 (optional, extend a GPIB interface using the USB-GPIB interface converter option)
Rear Output Interface	1 (DP811/DP813)

Environment	
Cooling Method	Fan Cooling
Working Temperature	0°C to 40°C
Storage Temperature	-40°C to 70°C
Humidity	5% to 80% relative humidity
Altitude	Below 1,500m

Note^[1]: The accuracy parameters are acquired via calibration under 25°C after 1-hour warm-up.

Note^[2]: The maximum time required for the output to change accordingly after receiving the APPLY and SOURce commands.

Note^[3]: The variation of the output within 8 hours after 30-minute warm-up when the load circuit and environment temperature are constant.

Chapter 6 Appendix

Appendix A: Accessories and Options

	Description	Order NO.
Models	Programmable Linear DC Power Supply (Three-channel)	DP832
	Programmable Linear DC Power Supply (Three-channel)	DP831
	Programmable Linear DC Power Supply (Dual-channel)	DP822
	Programmable Linear DC Power Supply (Dual-channel)	DP821
	Programmable Linear DC Power Supply (Single-channel)	DP813
	Programmable Linear DC Power Supply (Single-channel)	DP811
Standard Accessories	Power Cord	--
	USB Cable	CB-USBA-USBB-FF-150
	Fuse 50T-032H 250V 3.15A (DP832/DP822/DP813/DP811)	--
	Fuse 50T-025H 250V 2.5A (DP831/DP821)	--
	Short-circuit Equipment (DP822/DP821/DP813/DP811)	--
	Digital I/O Interface Connecting Terminal	Terminal-Digital I/O-DP800
Optional Accessories	Provide high-resolution setting	HIRES-DP800
	Provide 4 trigger input and output channels	DIGITALIO-DP800
	Provide on-line monitor and analysis functions	AFK-DP800
	Provide RS232 and LAN communication interfaces	INTERFACE-DP800
	USB to GPIB Interface Converter	USB-GPIB
	DP800 Series Rack Mount Kit (Single Instrument)	RM-1-DP800
	DP800 Series Rack Mount Kit (Two Instruments)	RM-2-DP800
	DP800 Series Red Safety Plug	SPR-DP800
	DP800 Series Black Safety Plug	SPB-DP800
DP800 Series Green Safety Plug	SPG-DP800	

Note: For all the accessories and options, please contact the local office of **RIGOL**.

Appendix B: Warranty

RIGOL TECHNOLOGIES CO., LTD. (hereinafter referred to as **RIGOL**) warrants that the product will be free from defects in materials and workmanship within the warranty period. If a product proves defective within the warranty period, **RIGOL** guarantees free replacement or repair for the defective product.

To get repair service, please contact with your nearest **RIGOL** sales or service office.

There is no other warranty, expressed or implied, except such as is expressly set forth herein or other applicable warranty card. There is no implied warranty of merchantability or fitness for a particular purpose. Under no circumstances shall **RIGOL** be liable for any consequential, indirect, ensuing, or special damages for any breach of warranty in any case.

Index

Advanced Functions.....	2-31	Hardware Flow Control.....	2-56
All File.....	2-46	Input Power Requirements.....	1-13
Analysis object.....	2-34	IP Address.....	2-54
analysis parameters.....	2-33	IP Configuration Mode.....	2-52
analysis results.....	2-34	Key Locking.....	2-70
Auto IP.....	2-53	Keyboard Lock.....	2-58
Back.....	1-7	LAN Parameters.....	2-52
Bitmap File.....	2-46	LAN Status.....	2-52
Brightness.....	2-41	MAC Address.....	2-53
Built-in help system.....	1-18	Manual IP.....	2-53
CC.....	2-6	Menu Keys.....	1-10
Channel (Range) Selection.....	1-5	Monitor Condition.....	2-36
Channel output terminals.....	1-8	Monitor Stop Mode.....	2-36
Check the output mode.....	2-4	Number of Cycles of Delayer.....	2-27
Connect the channel output terminals.....	2-2	Number of Cycles of Timer.....	2-17
Constant current output.....	2-6	Number of Output Groups of Delayer.....	2-26
Constant voltage output.....	2-2	Number of Output Groups of Timer.....	2-17
Construct the output waveform ..	2-24	OK.....	1-7
Contrast.....	2-41	on delay/off delay.....	2-28
Control Source.....	2-39	On/Off Sync.....	2-12
Copy and Paste a file.....	2-50	option installation file.....	2-68
Current Time.....	2-35	option license.....	2-68
CV.....	2-2	Output Interface.....	2-4
Data Line.....	2-38	Output Response.....	2-38
Delay File.....	2-46	Output Signal.....	2-40
Delay Parameters.....	2-27	Output Terminals.....	1-8
Delayer.....	2-15	Parameter Input Area.....	1-6
Delayer End State.....	2-27	Power Supply Parallel Connection ..	2-9
Delayer Stop Condition.....	2-29	Power Supply Series Connection... ..	2-8
Delete a file.....	2-49	Power Switch Key.....	1-10
DHCP.....	2-53	Preset.....	1-7
display mode.....	2-42	Read a file.....	2-49
Display Mode Switch.....	1-10	Record File.....	2-46
Display type.....	2-34	Record period.....	2-32
DNS Server.....	2-54	RGB luminance.....	2-41
Enable.....	2-39, 2-40	RS232 Parameters.....	2-56
FixTime.....	2-28	Save a File.....	2-47
Function Menu Area.....	1-9	Sense connecting method.....	2-13
Fuse.....	1-14	Sense Mode.....	2-13
Gateway.....	2-54	Sense terminals.....	1-8
GPIO Address.....	2-57	Set the current.....	2-3
Ground terminal.....	1-8		

Set the overcurrent protection.....	2-3	Track Function	2-10
Set the voltage	2-2	Tracking Mode	2-10
Source under Control.....	2-38	Trigger Condition	2-40
State File.....	2-46	trigger connections	2-37
state generation.....	2-28	Trigger Input	2-37
Store and Recall.....	2-45	Trigger Output.....	2-37
Subnet Mask.....	2-54	Trigger Type	2-38
templet	2-18	Turn on the output.....	2-3
templet editing object.....	2-18	User Interface	1-17
time base value and step.....	2-29	User-defined Setting	2-66
time generation	2-28	User-defined Start-up Interface..	2-43
Timer	2-15	Utility.....	2-51
Timer End State.....	2-17	VISA Descriptor	2-53
Timer File.....	2-46	voltage selector	1-13
Timer Parameters.....	2-17		