

Specification

Nominal Voltage	12V	
Nominal Capacity(10HR)	55.0AH	
Dimension	Length	228 ±3mm (8.98 inches)
	Width	137 ±2mm (5.39 inches)
	Container Height	210 ±3mm (8.27 inches)
	Total Height (with Terminal)	230 ±3mm (9.06 inches)
Approx Weight	Approx 17.7 Kg (39.0 lbs)	
Terminal	T9/T6	
Container Material	ABS	
Rated Capacity	59.0AH/2.95A	(20hr ,1.80V/cell,25°C/77°F)
	55.0AH/5.50A	(10hr,1.80V/cell,25°C/77°F)
	48.2AH/9.65A	(5hr,1.75V/cell,25°C/77°F)
	43.7AH/14.6A	(3hr,1.75V/cell,25°C/77°F)
	35.5AH/35.5A	(1hr,1.60V/cell,25°C/77°F)
Max. Discharge Current	660A (5s)	
Internal Resistance	Approx 7.5mΩ	
Operating Temp.Range	Discharge : -15~50°C (5~122°F)	
	Charge : 0~40°C (32~104°F)	
	Storage : -15~40°C (5~104°F)	
Nominal Operating Temp. Range	25 ±3 °C (77 ±5 °F)	
Cycle Use	Initial Charging Current less than 16.5A. Voltage	
	14.4V~15.0V at 25°C (77°F) Temp. Coefficient -30mV/°C	
Standby Use	No limit on Initial Charging Current Voltage	
	13.5V~13.8V at 25°C (77°F) Temp. Coefficient -20mV/°C	
Capacity affected by Temperature	40°C (104°F)	103%
	25°C (77°F)	100%
	0°C (32°F)	86%
Self Discharge	Leaftron LTC series batteries may be stored for up to 6 months at 25°C (77°F) and then a freshening charge is required. For higher temperatures the time interval will be shorter.	



Applications

- ◆ Electric tools
- ◆ Vehicle in place of walking
- ◆ Lawn mowers
- ◆ Golf trolleys and golfcart
- ◆ Portable apparatus, lights and instruments;
- ◆ Electric toys
- ◆ Illumination light
- ◆ Fire alarms
- ◆ Portable power
- ◆ Wheelchairs
- ◆ Medical equipments.

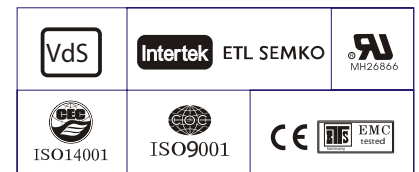

Constant Current Discharge (Amperes) at 25 °C (77°F)

F.V/Time	10min	15min	20min	30min	45min	1h	2h	3h	4h	5h	6h	8h	10h	20h
1.85V/cell	80.5	67.8	59.2	42.6	33.8	27.5	17.1	13.3	10.8	8.76	7.64	6.23	5.19	2.92
1.80V/cell	102.9	81.9	70.0	50.3	39.4	30.8	18.6	14.3	11.5	9.40	8.19	6.61	5.50	2.95
1.75V/cell	113.1	89.4	75.3	52.2	40.8	32.2	19.3	14.6	11.8	9.65	8.42	6.73	5.56	2.98
1.70V/cell	123.2	95.5	79.1	54.3	42.5	33.2	20.1	15.0	12.1	9.89	8.59	6.82	5.61	3.03
1.65V/cell	133.0	101.5	84.1	57.3	43.5	34.3	20.6	15.6	12.5	10.2	8.78	6.93	5.73	3.07
1.60V/cell	144.4	108.6	89.5	60.5	45.4	35.5	21.3	16.1	12.9	10.5	8.97	6.99	5.79	3.09

Constant Power Discharge (Watts/cell) at 25 °C (77°F)

F.V/Time	10min	15min	20min	30min	45min	1h	2h	3h	4h	5h	6h	8h	10h	20h
1.85V/cell	150.2	127.7	112.8	81.9	65.5	53.3	33.2	26.0	21.1	17.2	15.1	12.3	10.3	5.84
1.80V/cell	189.4	152.0	131.4	95.4	75.5	59.4	36.1	27.8	22.4	18.4	16.1	13.1	10.9	5.89
1.75V/cell	205.6	164.5	140.1	98.6	78.0	61.9	37.3	28.3	22.9	18.9	16.5	13.3	11.0	5.94
1.70V/cell	220.9	174.3	146.4	102.2	80.9	63.7	38.7	29.0	23.4	19.3	16.9	13.5	11.1	6.04
1.65V/cell	236.7	184.2	154.8	107.3	82.6	65.6	39.6	30.1	24.2	19.8	17.2	13.6	11.3	6.11
1.60V/cell	252.6	194.6	163.2	112.2	85.3	67.4	40.7	30.9	24.8	20.3	17.5	13.8	11.4	6.14

Dimensions

Unit: mm [inches]
Terminal: T9

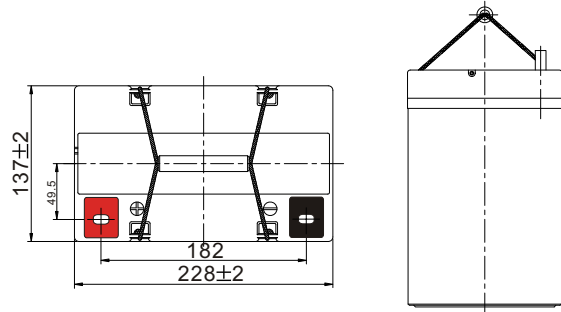
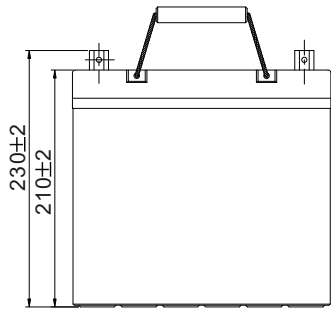
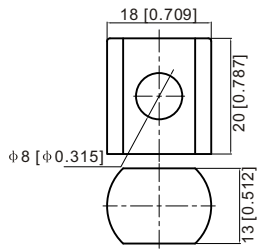

Discharge Characteristics

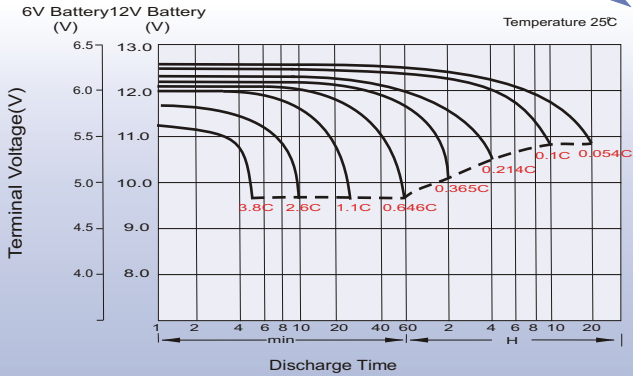

Charging Characteristics (cycle use)

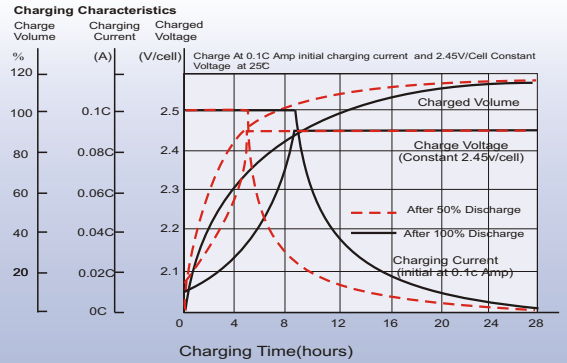

Temperature Effects in Relation to Battery Capacity

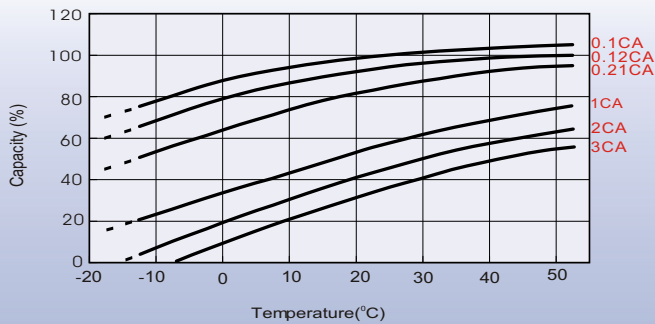

Cycle Life in Relation to Depth of Discharge

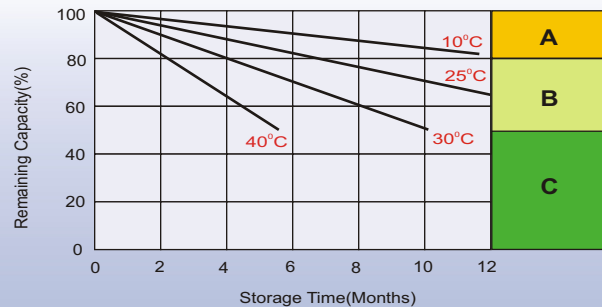
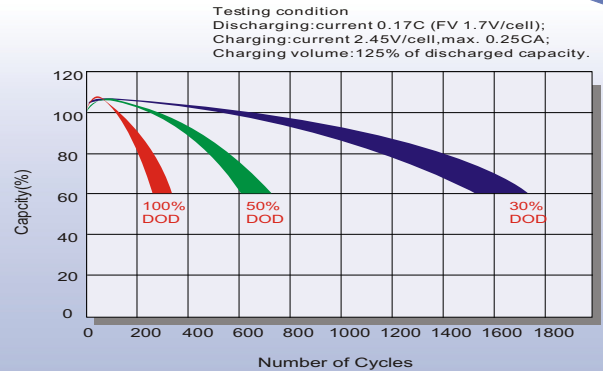

Self Discharge Characteristics

- A** No supplementary charge required
(Carry out supplementary charge before use if 100% capacity is required.)
- B** Supplementary charge required before use. Optional charging way as below:
 1. Charged for above 3 days at limited current 0.25CA and constant volatge 2.25V/cell.
 2. Charged for above 20hours at limited current 0.25CA and constant volatge 2.45V/cell.
 3. Charged for 8~10hours at limited current 0.05CA .
- C** Supplementary charge may often fail to recover the capacity.
The battery should never be left standing till this is reached.